



Pop-up ABC

"Pop-up ABC" is a fun picture book that children can move the 3 dimensional tricks and pictures and learn the alphabet. Each letter of the alphabet has a familiar motif little children will enjoy. Your children will improve artistic sentiments by making it and sharing it with merry talks together with the family and friends. The 26 pieces from A to Z can be stocked in a special case.

Assembly tip

- Writing the number of each section on its back side before cutting out the sections is highly recommended. (* This way, you can be sure which section is which even after cutting out the sections.)
- Fold and crease mountain folds and valley folds before applying glue.
- Take your time to cut out each piece carefully.
- Trace along the folds with a ruler and an exhausted pen (no ink) to get a sharper, easier fold.
- When applying glue to large areas, take care to prevent warping of paper that may be caused by over-application of glue. Apply small amounts of glue around the peripheral of the piece or use dual-sided tape to minimize warping.

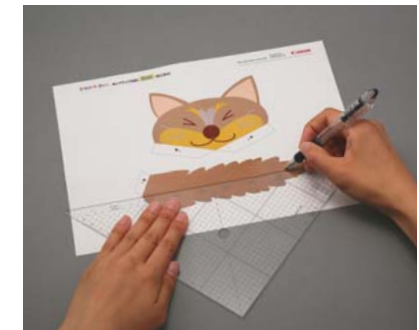

Necessary utensils

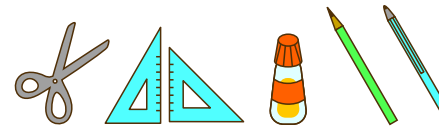

scissors, set square, glue, pencil, used ballpoint pen

Caution

- Please read the Assembly Instructions carefully, and assemble in order as shown on the pattern sheets.
- This papercraft involves using glue, scissors, and other utensils and materials that may be dangerous to young children. Please work somewhere out of reach of young children.

Notation Key

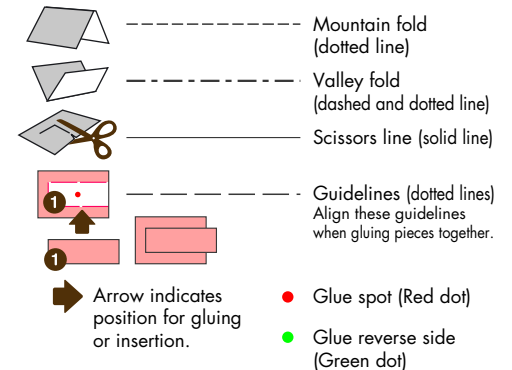

* The following are used in the assembly instructions.

Indicates reverse side of paper.

Indicates front/reverse of sections to be glued. Glue the same numbers to each other.

Assembly Instructions · Pattern

Forty-one A4 sheets (No. 1 to No. 41)

Apple



Baby



Cat



Dog





Gift



Hat



Materials

Prepare the materials. Cut out the parts and give mountain and valley folding in advance.

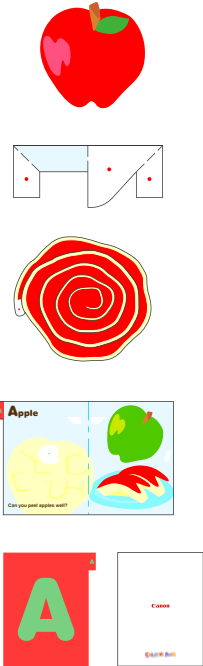

How to build the book Glue in the order of the numbers.

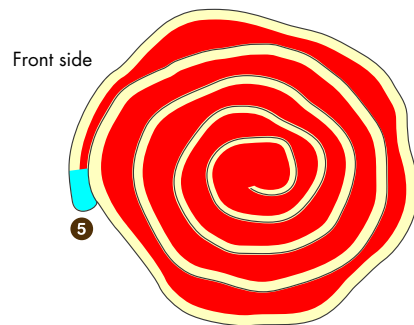
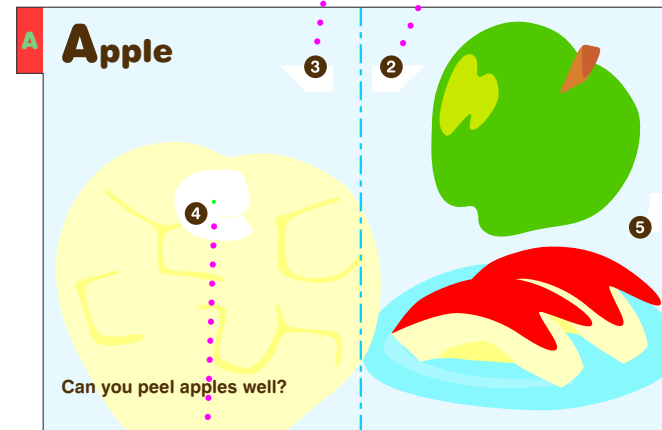
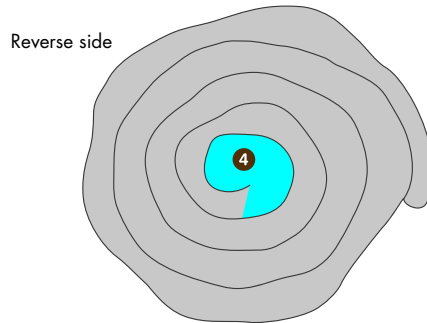
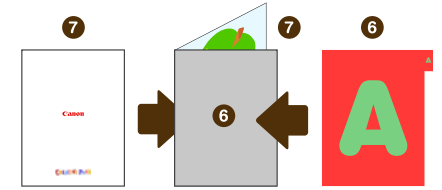
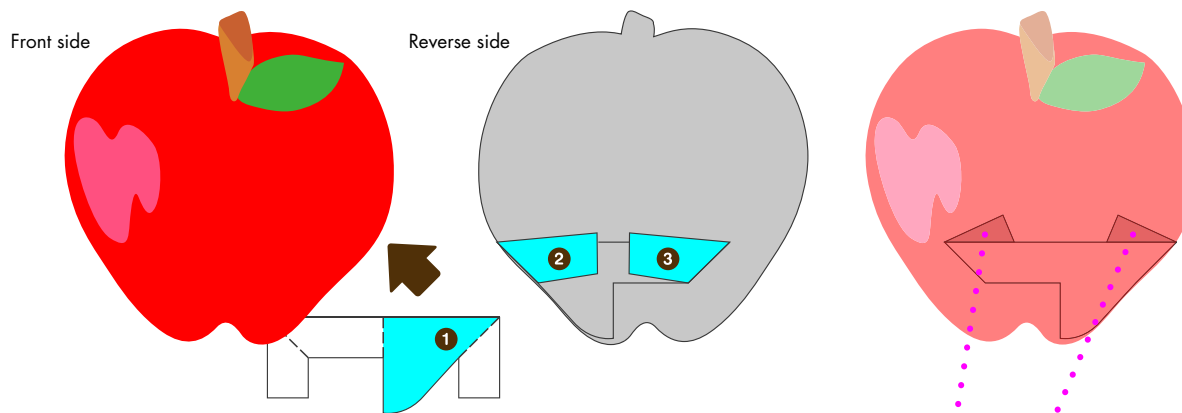

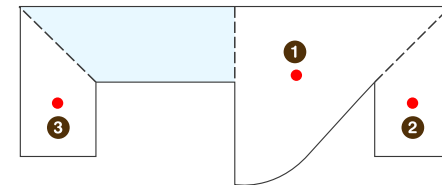
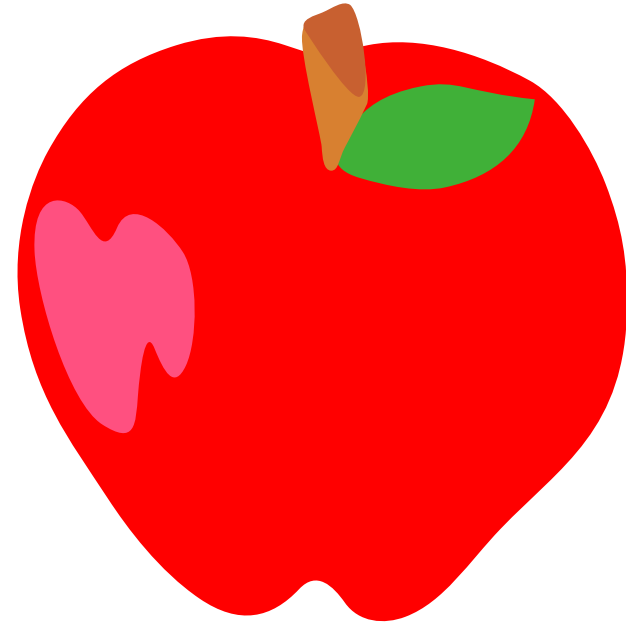

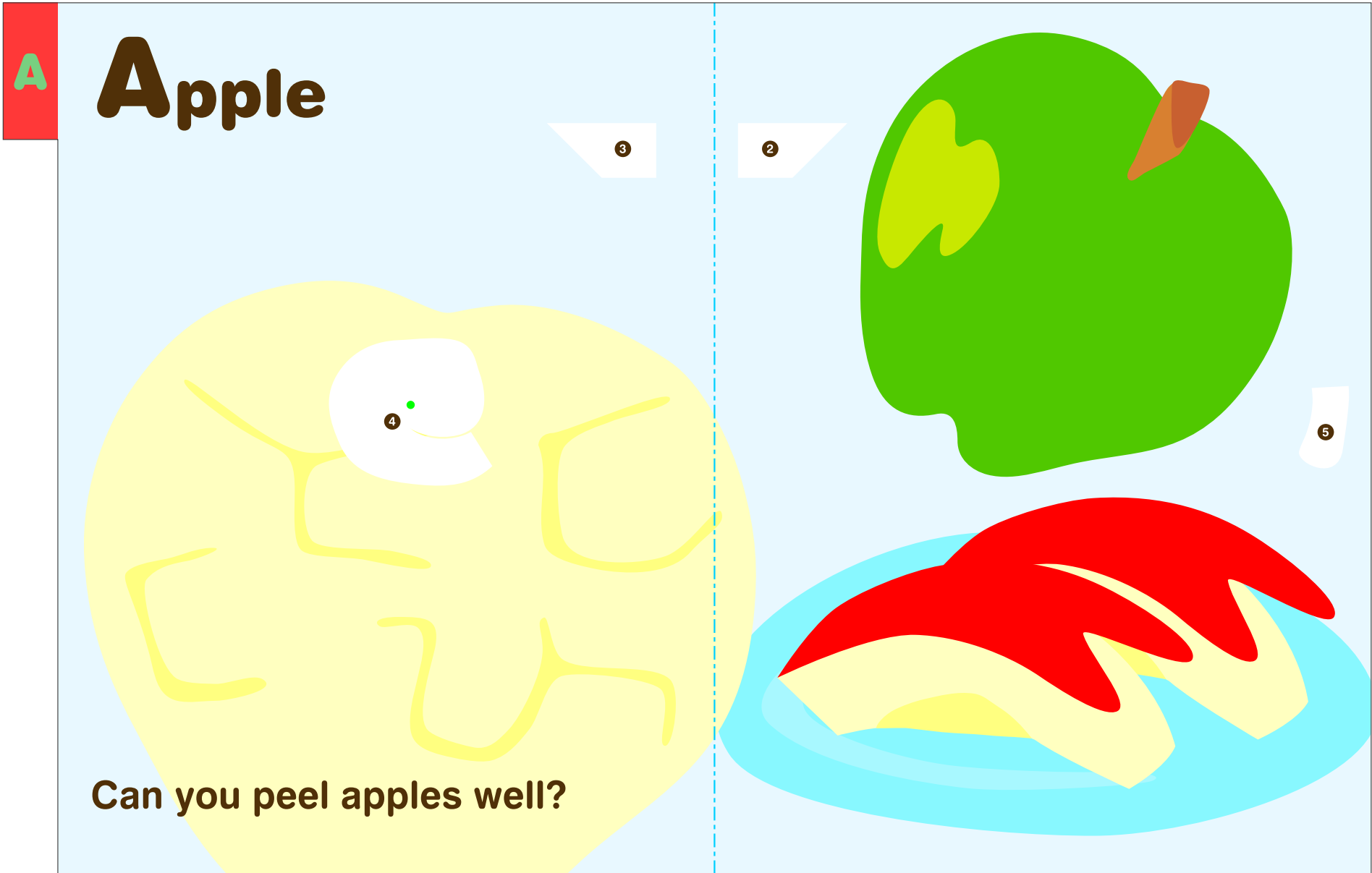

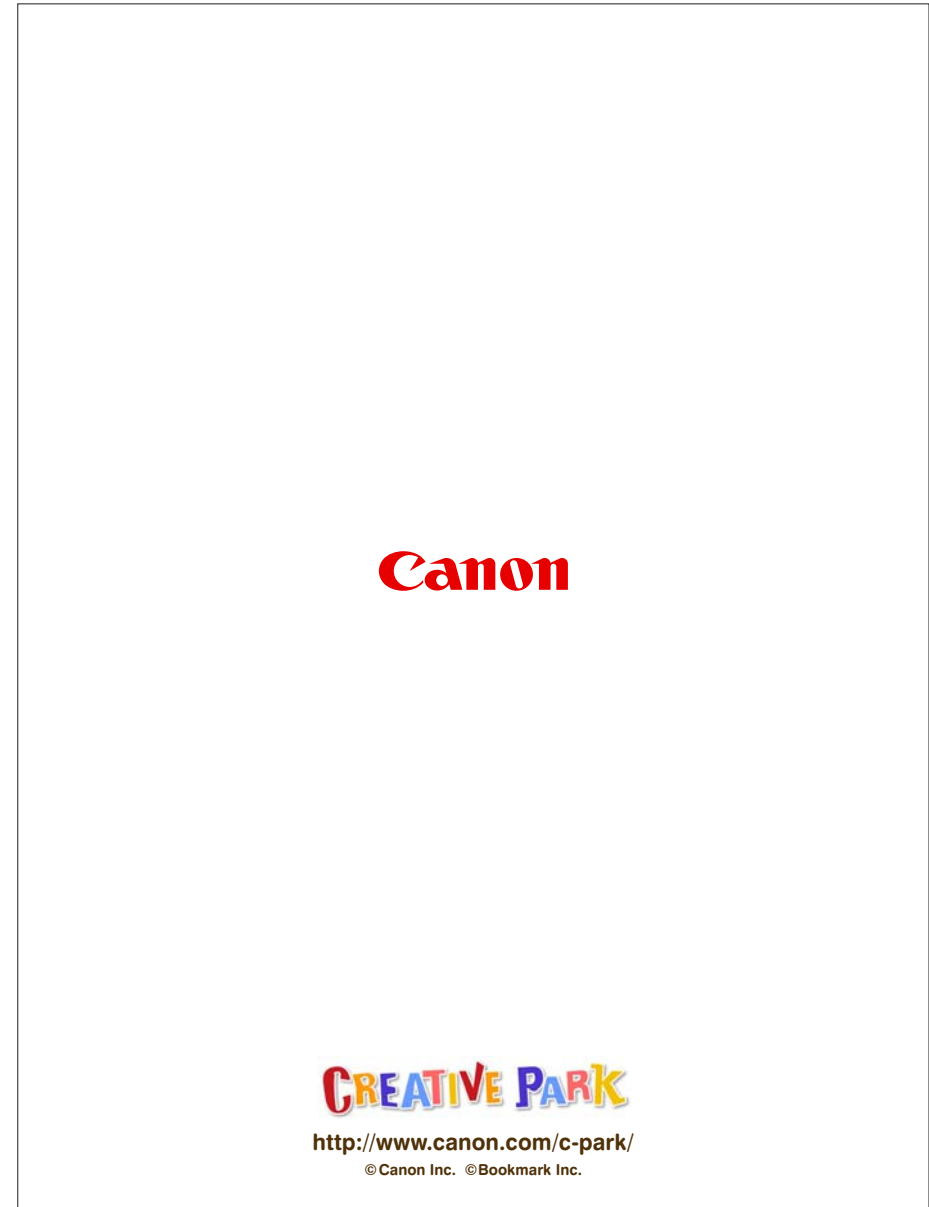

Materials

Prepare the materials. Cut out the parts and give mountain and valley folding in advance.

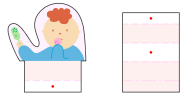
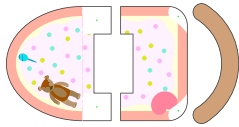

How to build the book Glue in the order of the numbers.

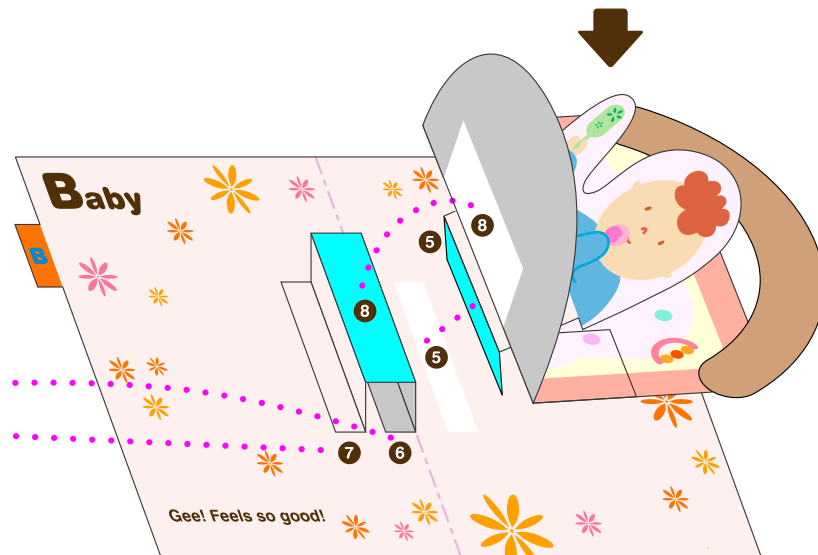
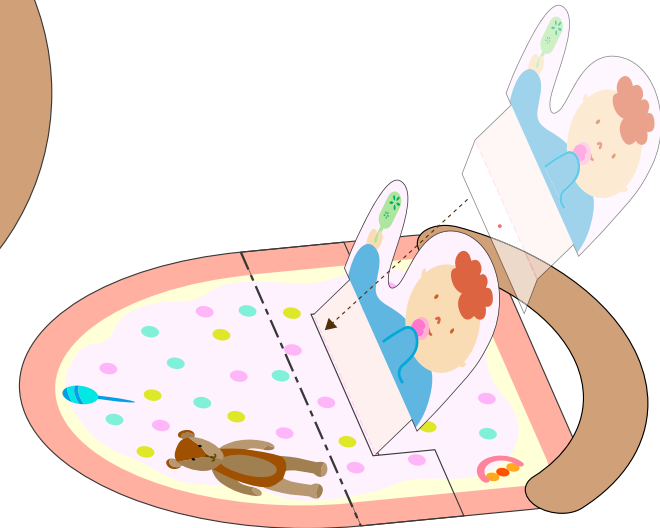
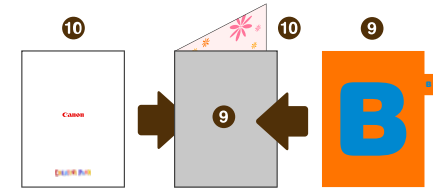
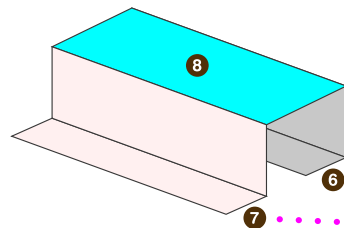
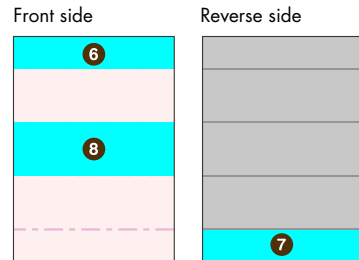
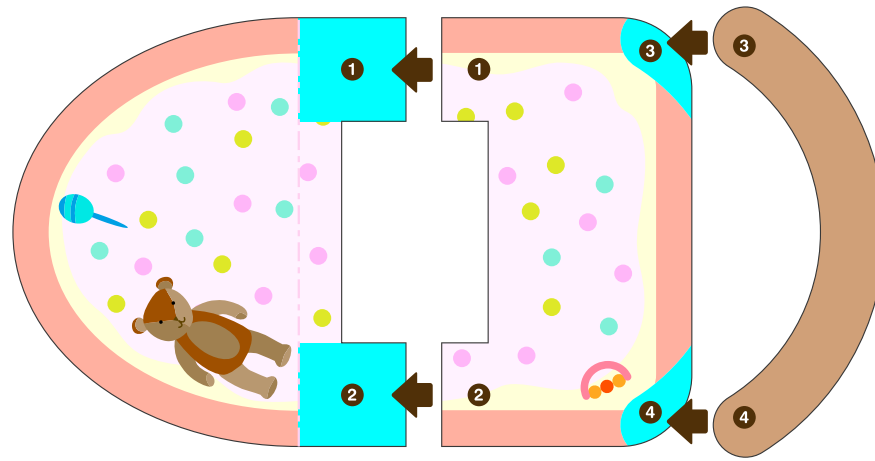

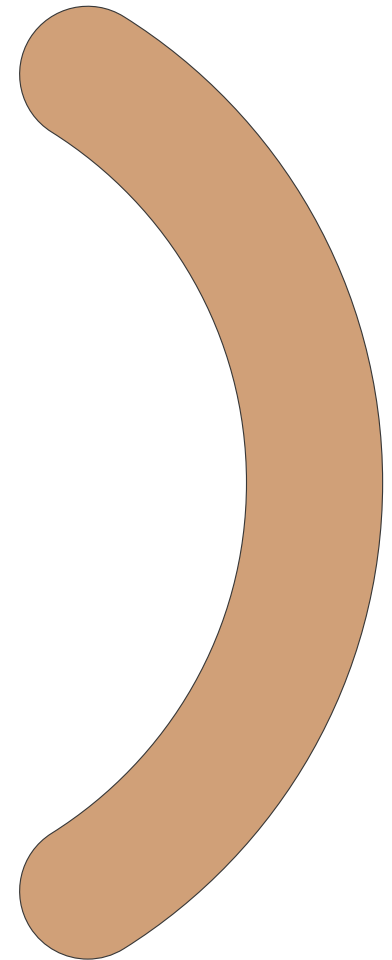
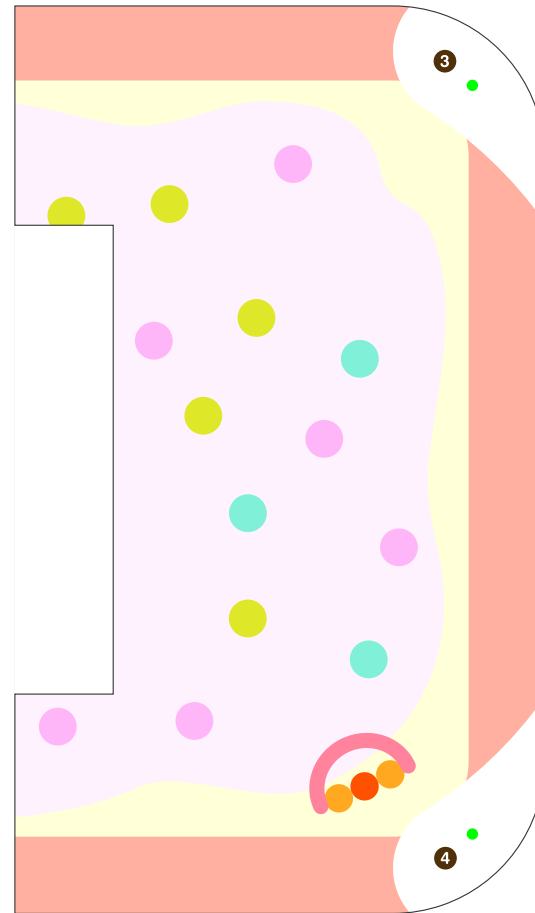
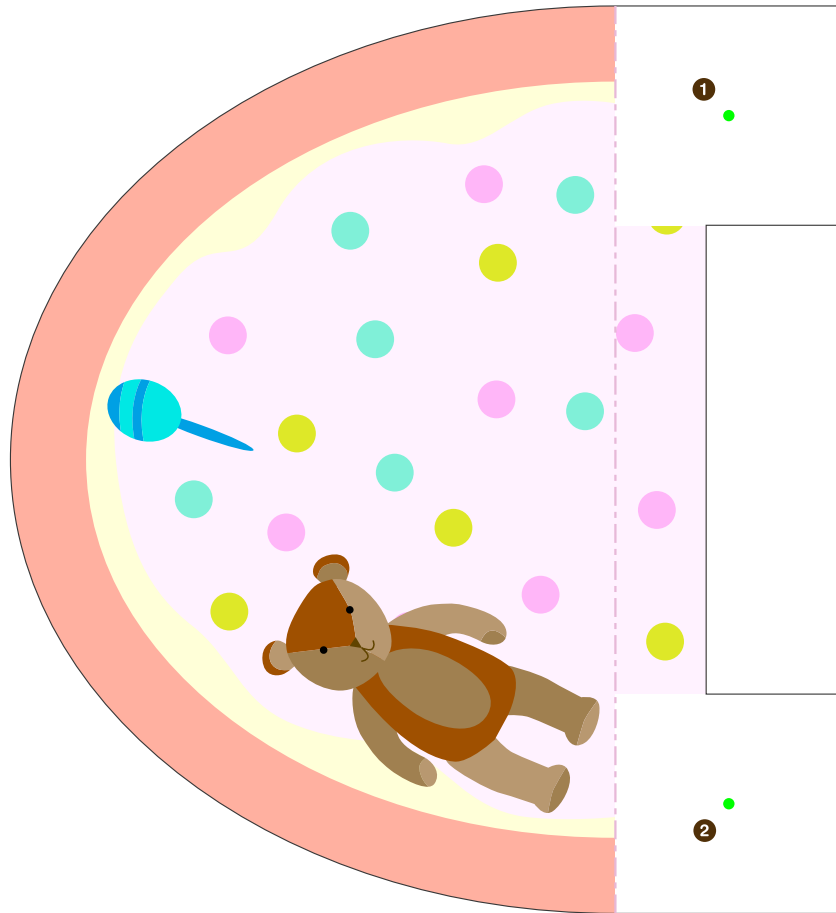

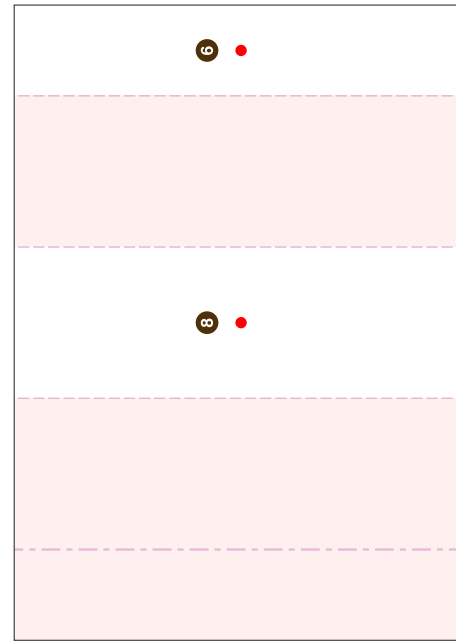

B

Baby

Gee! Feels so good!

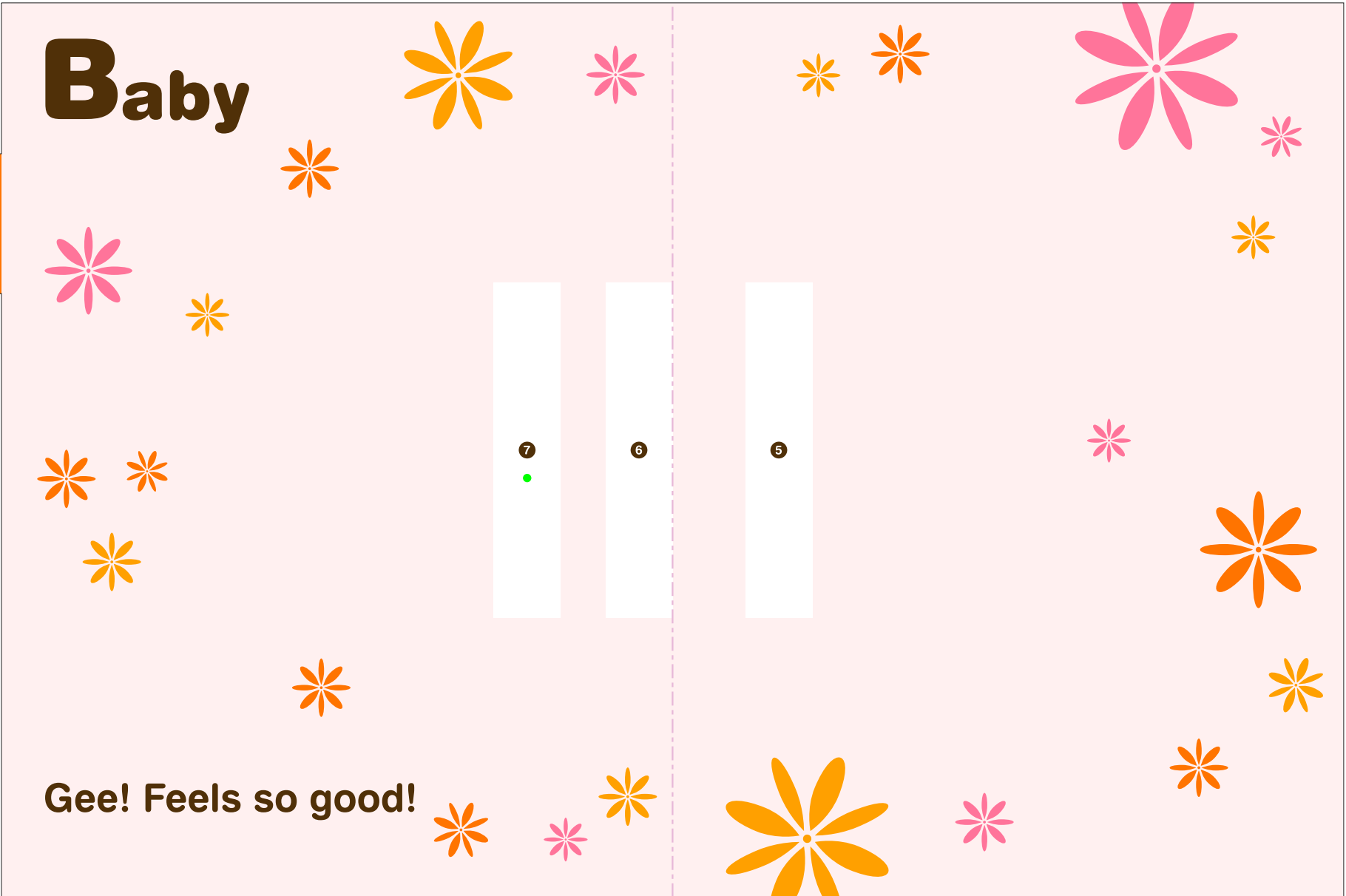

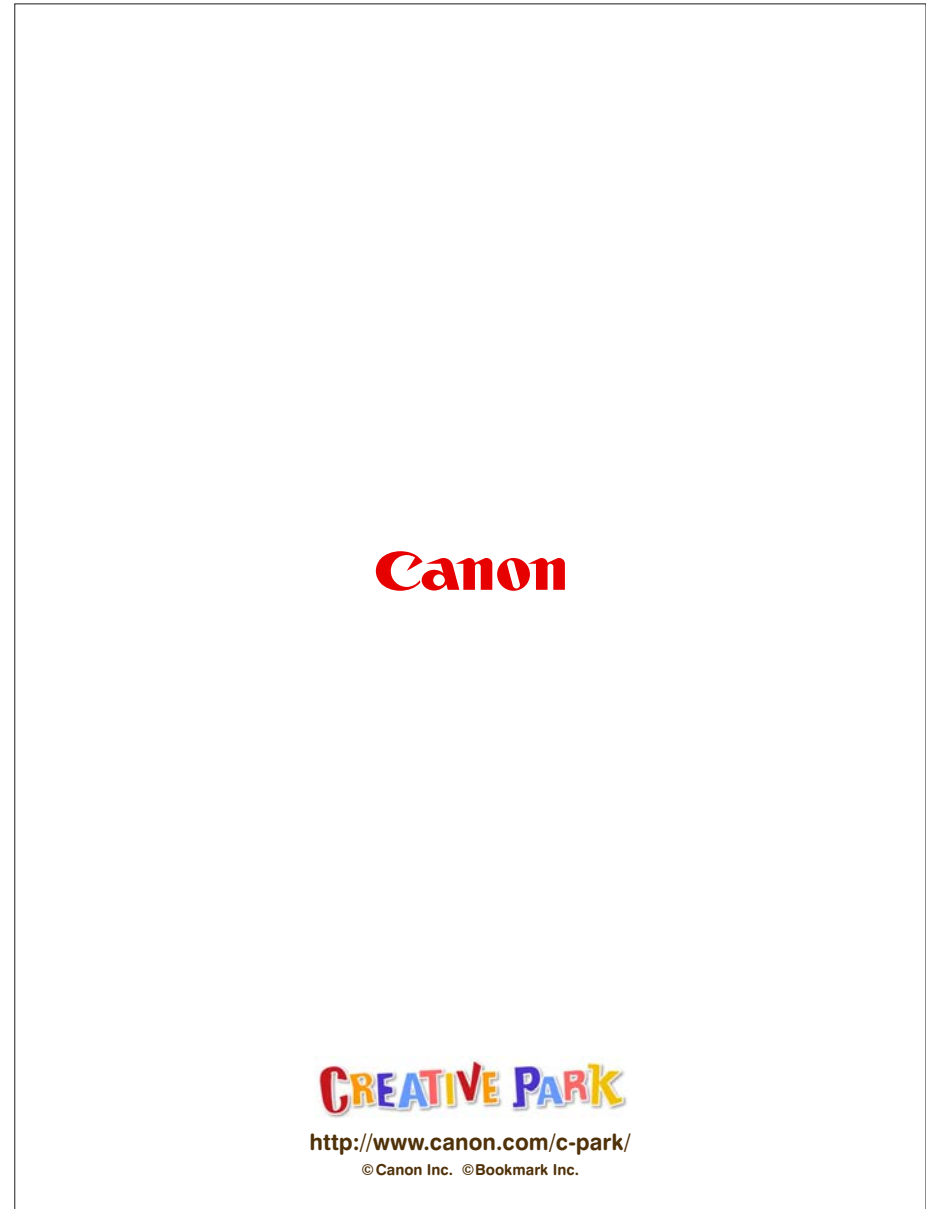

Materials

Prepare the materials. Cut out the parts and give mountain and valley folding in advance.

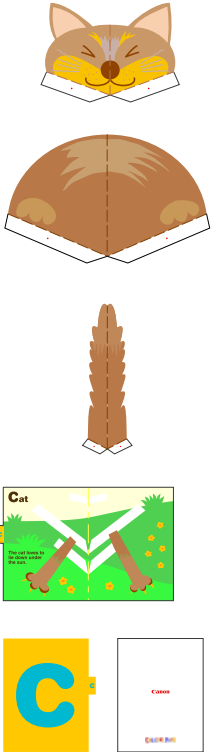

How to build the book Glue in the order of the numbers.

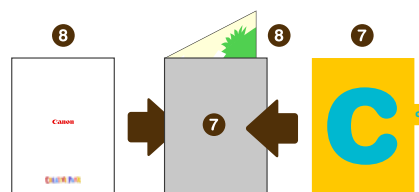
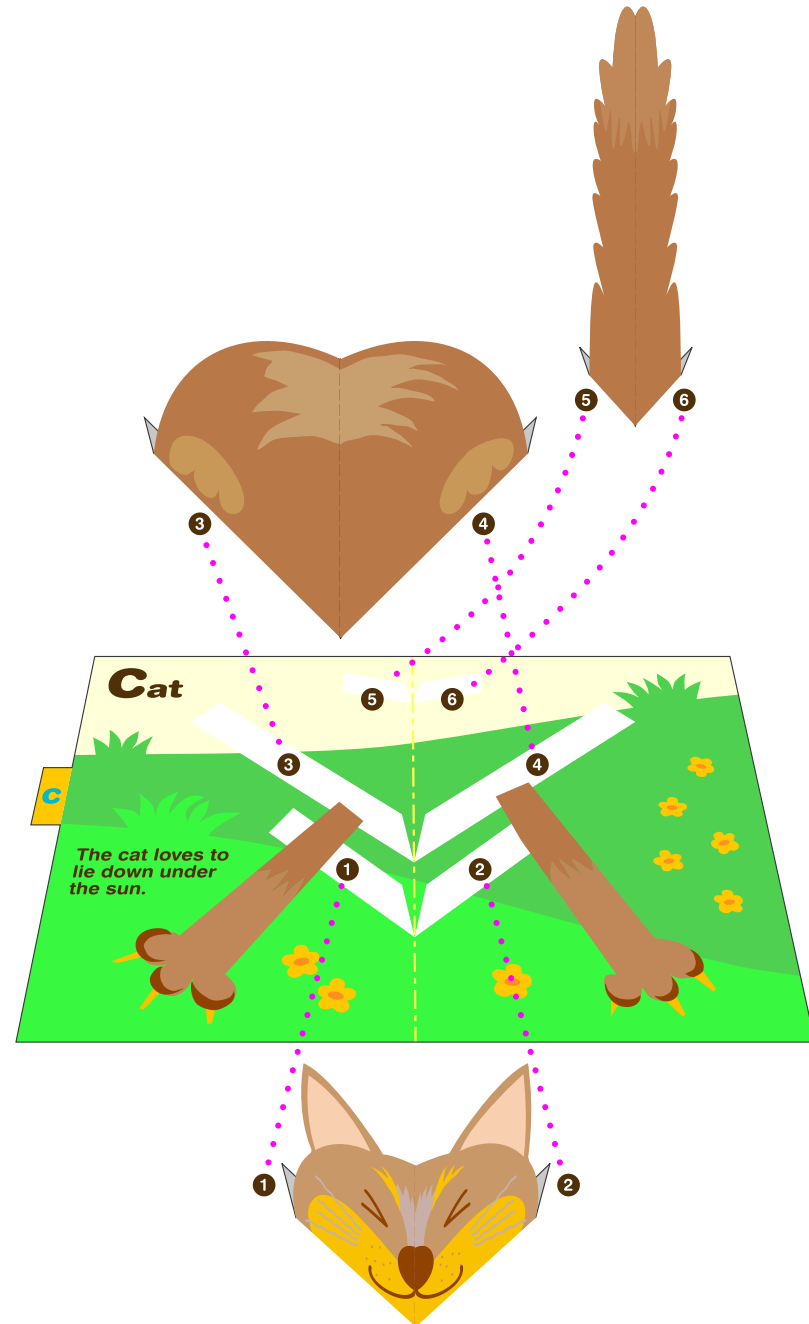
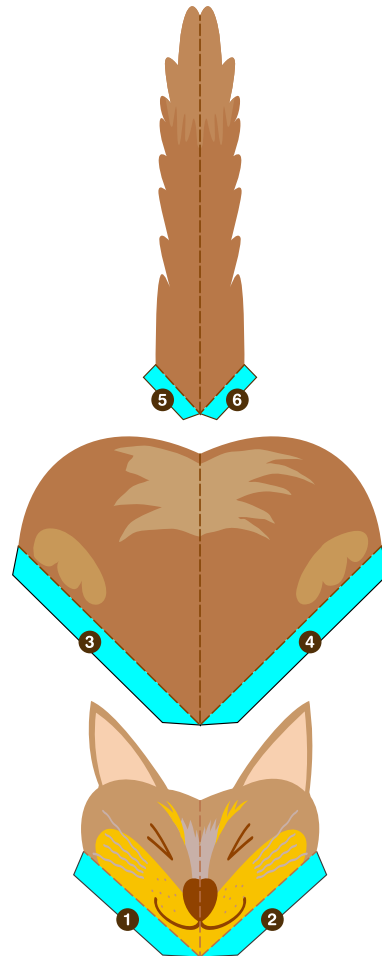

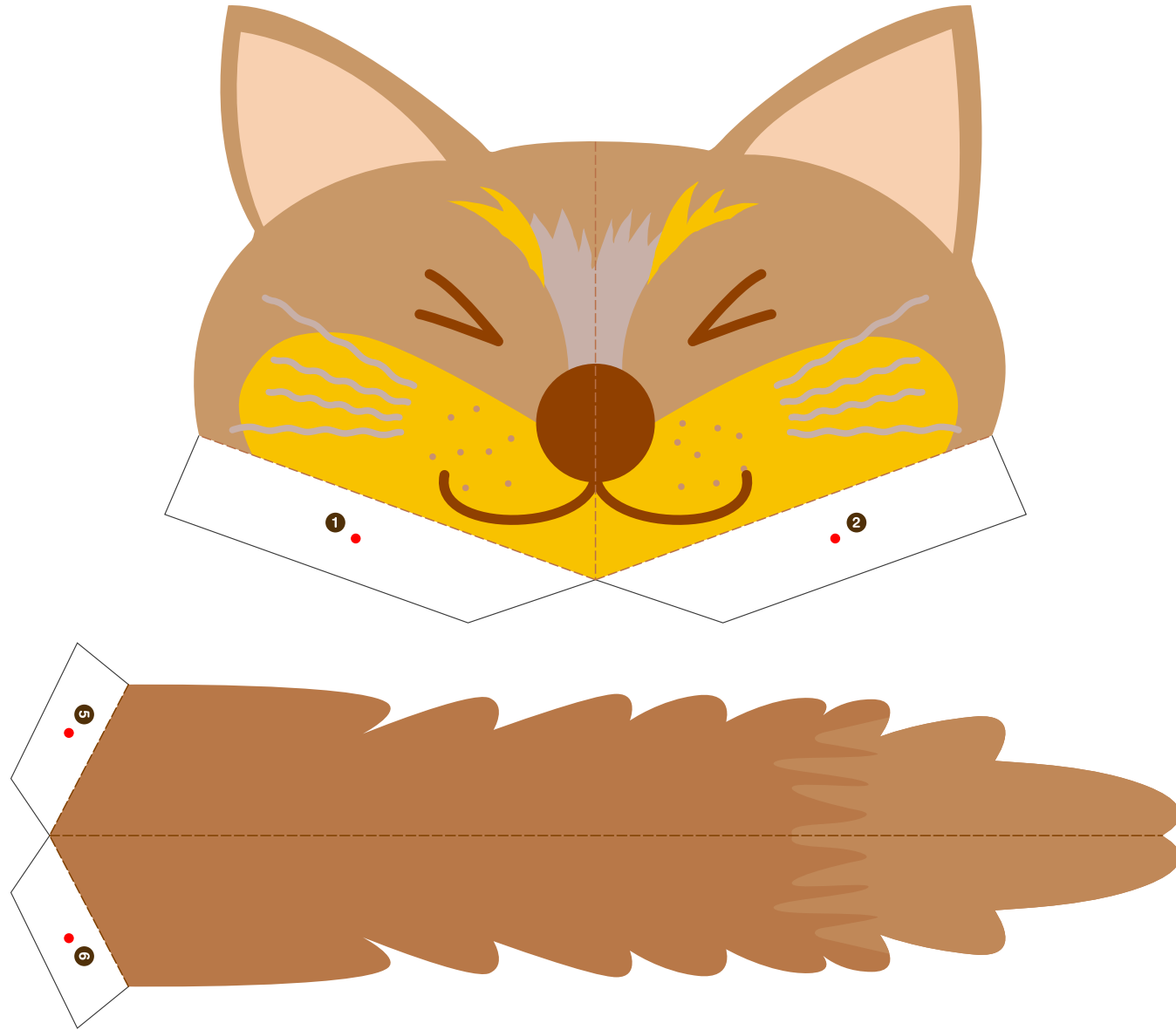

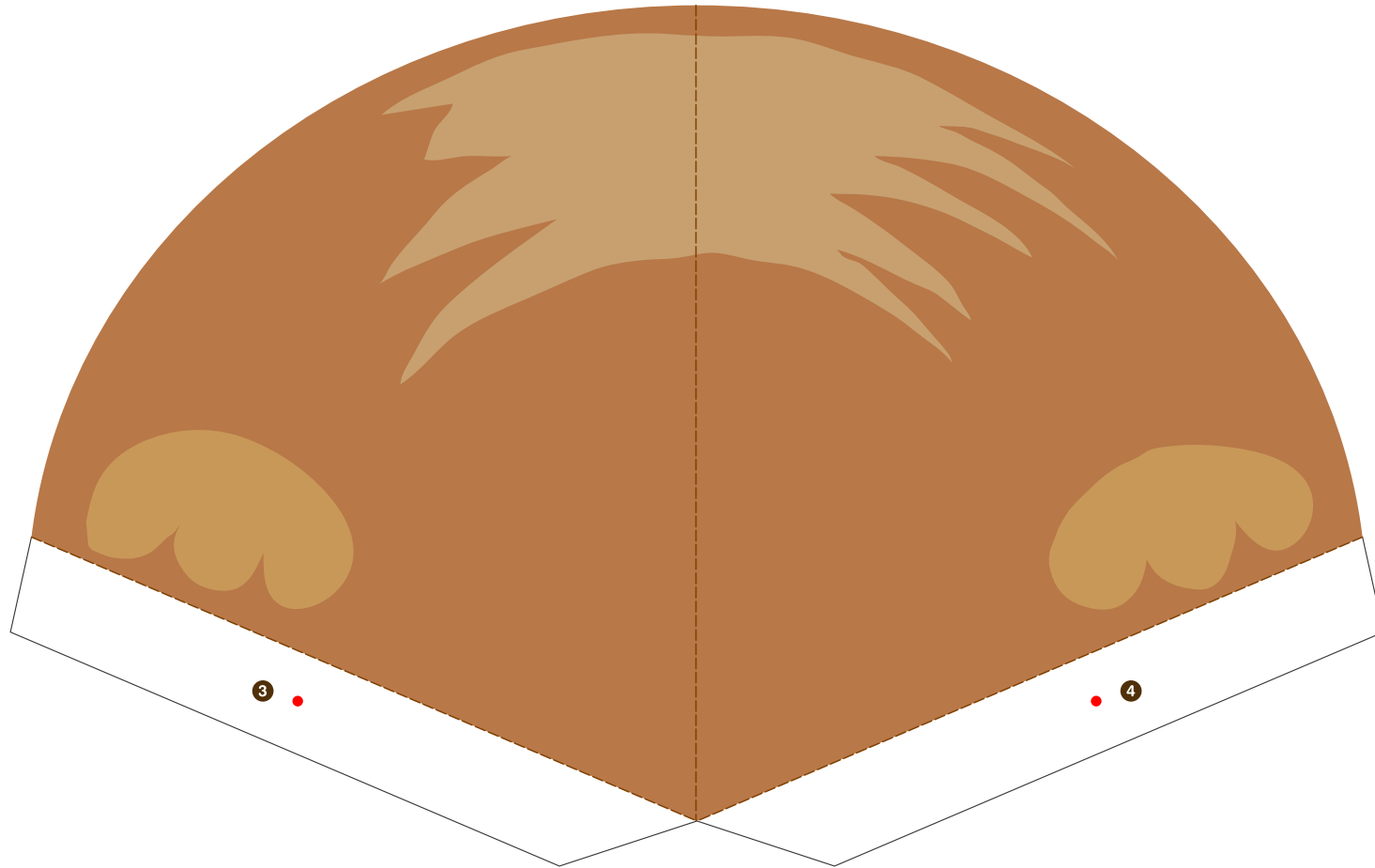

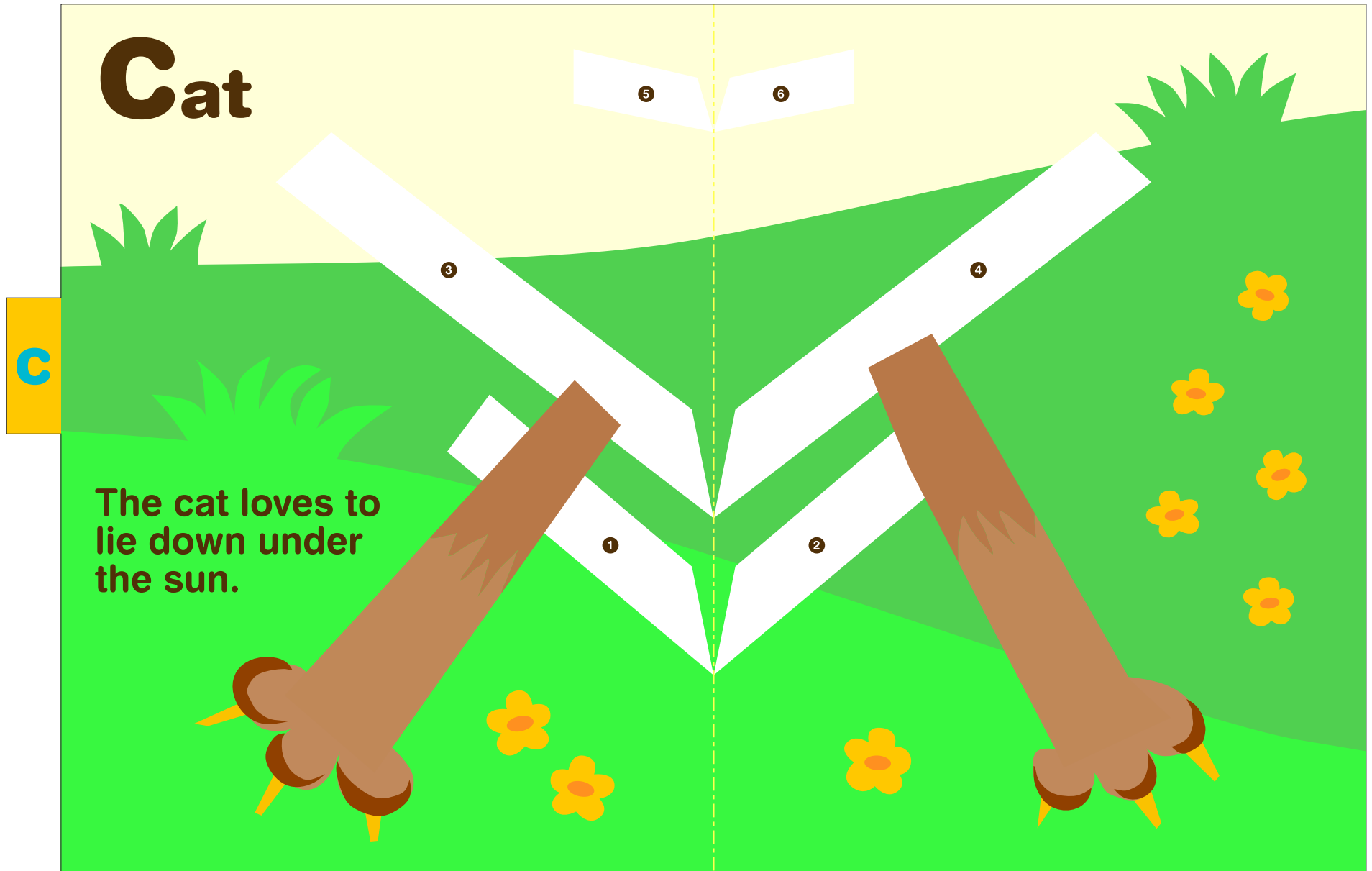

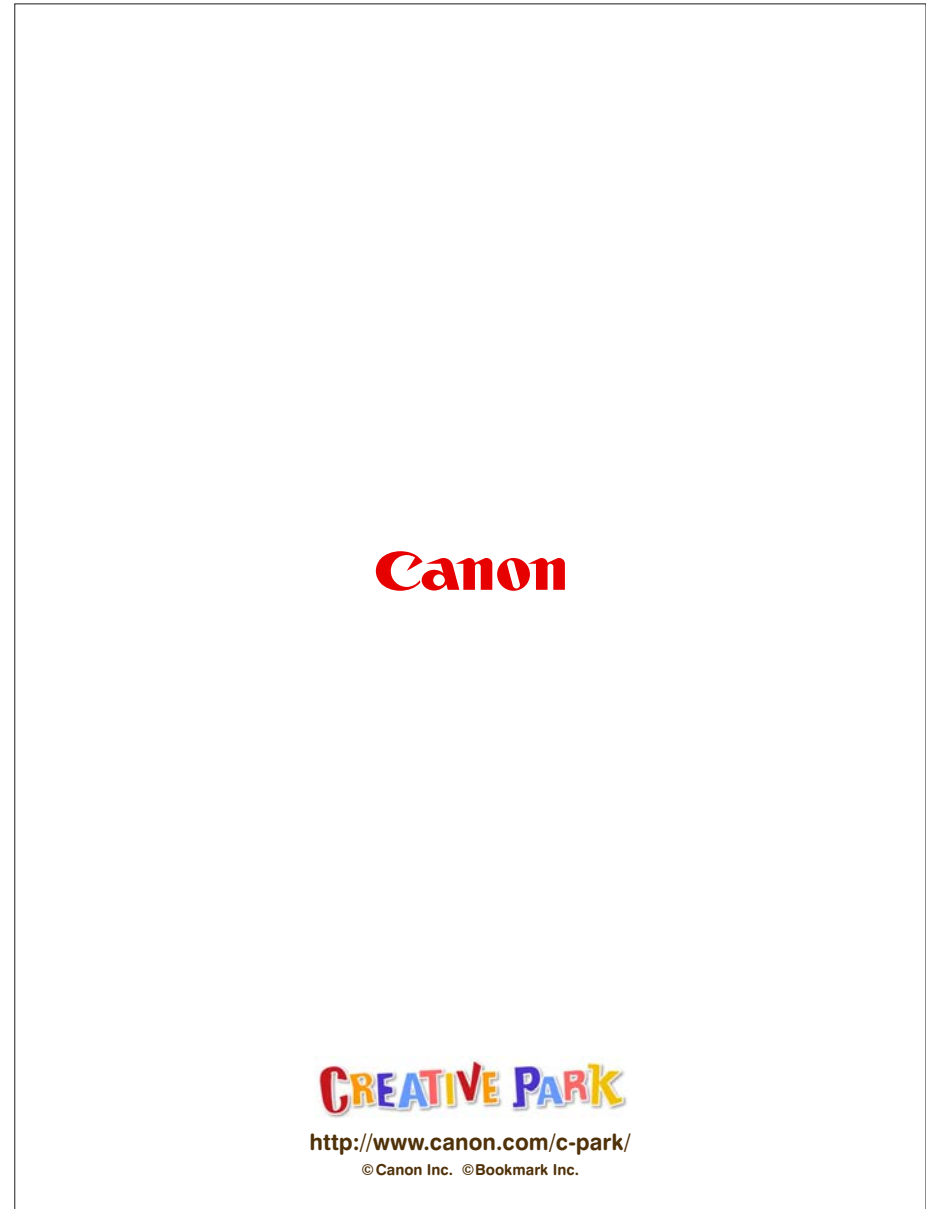
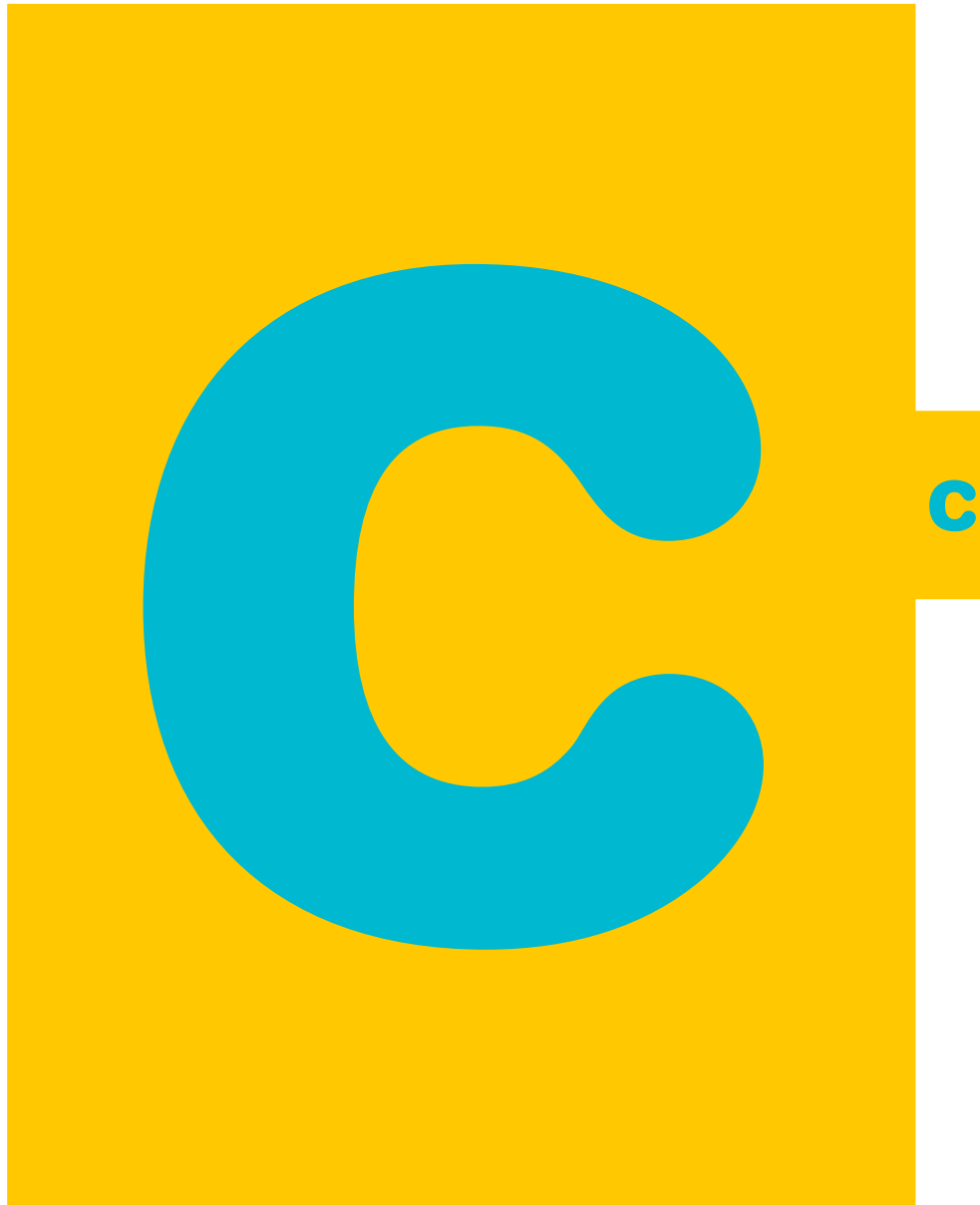

Materials

Prepare the materials. Cut out the parts and give mountain and valley folding in advance.

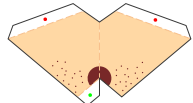

How to build the book Glue in the order of the numbers.

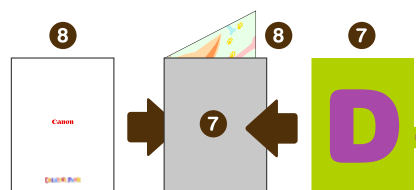
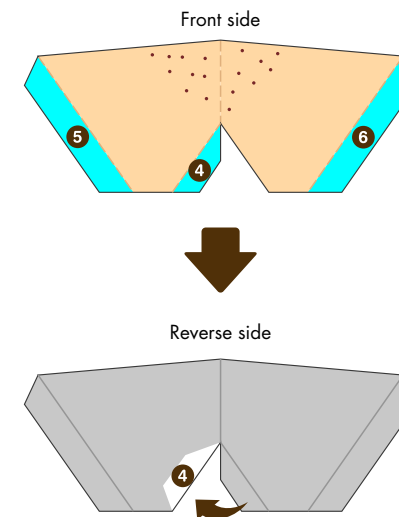
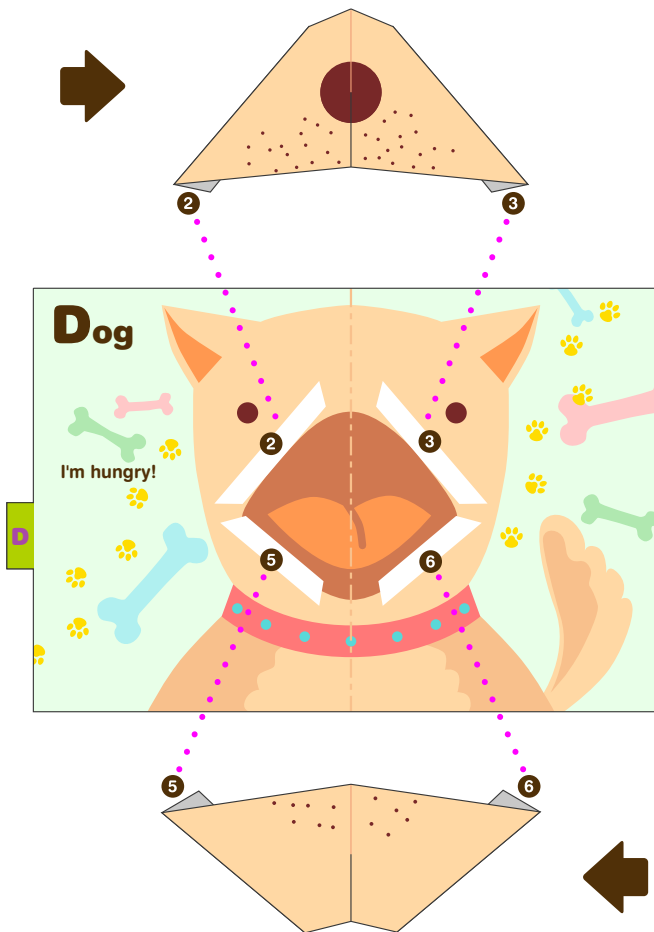
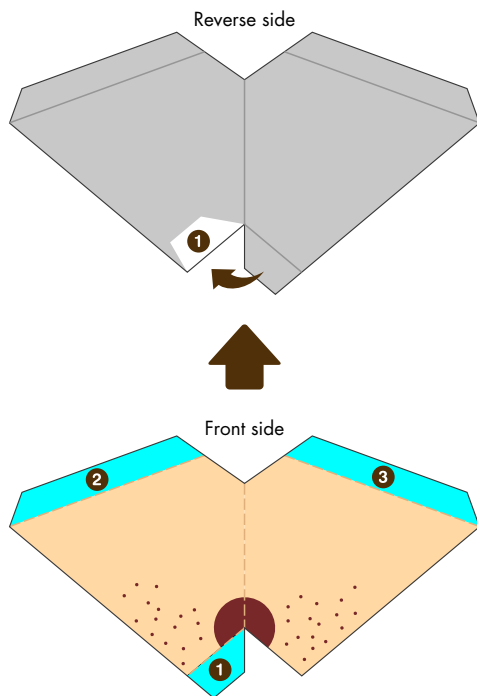

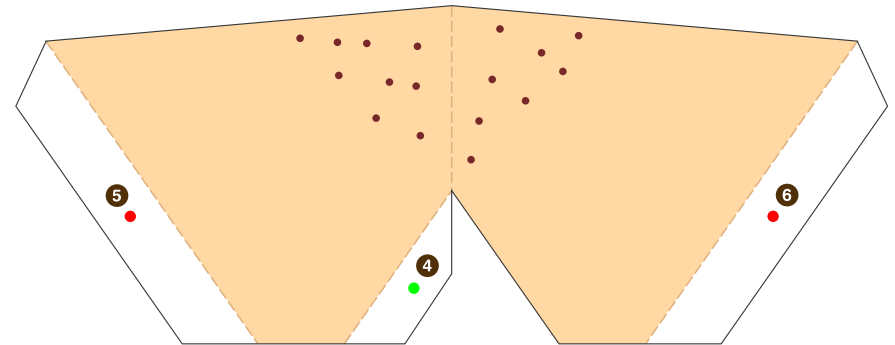
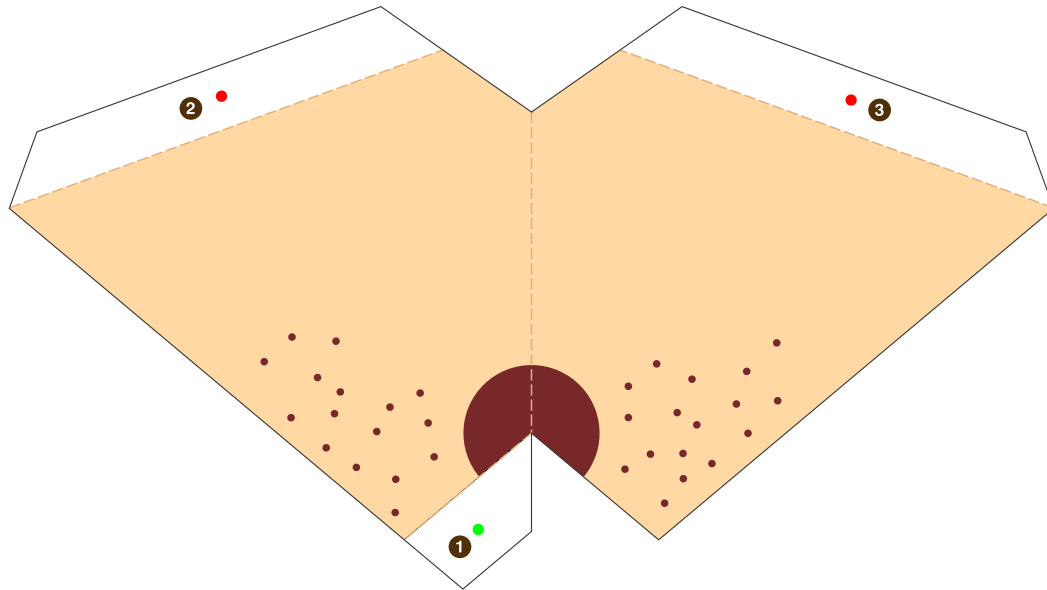

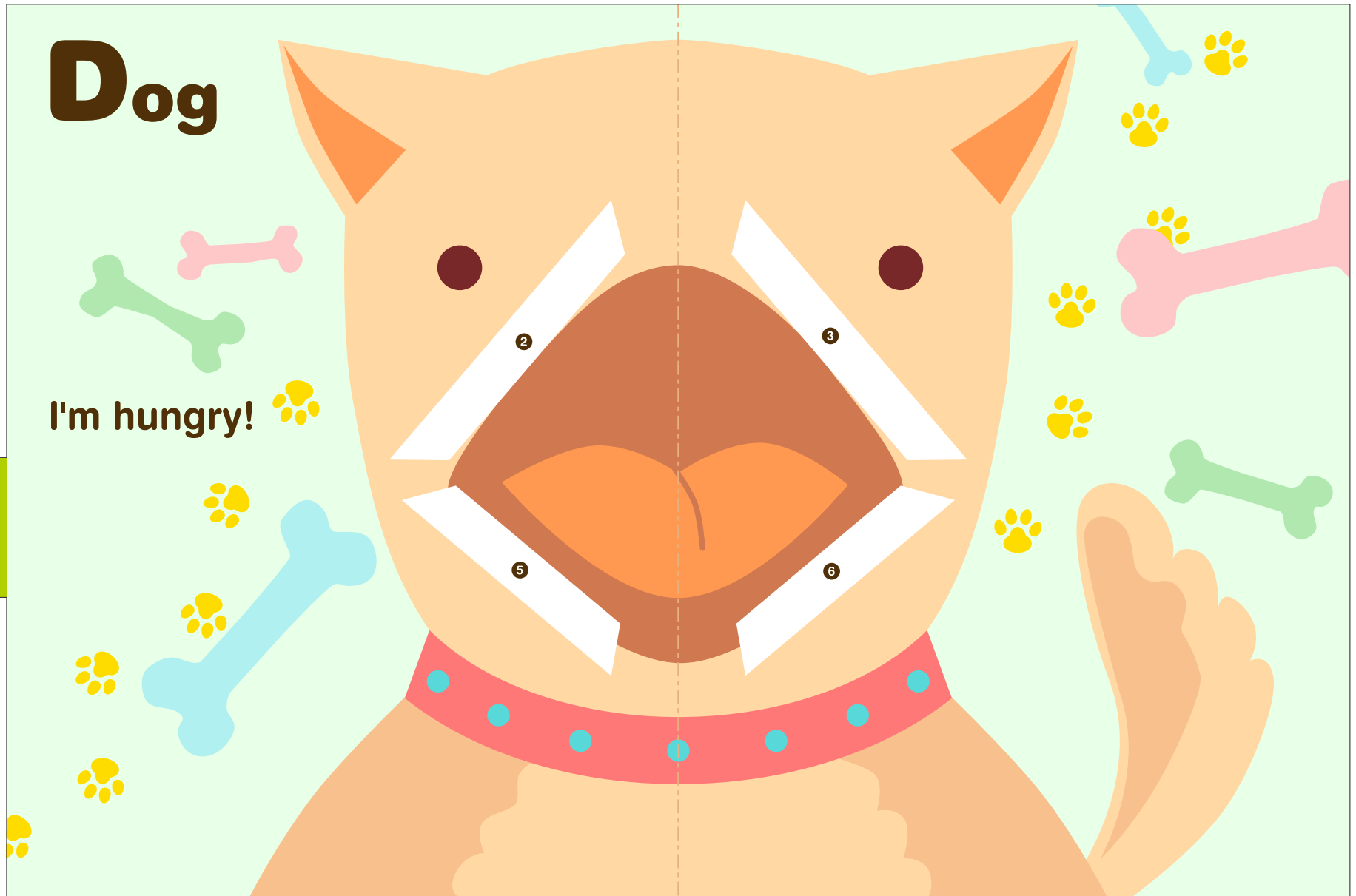

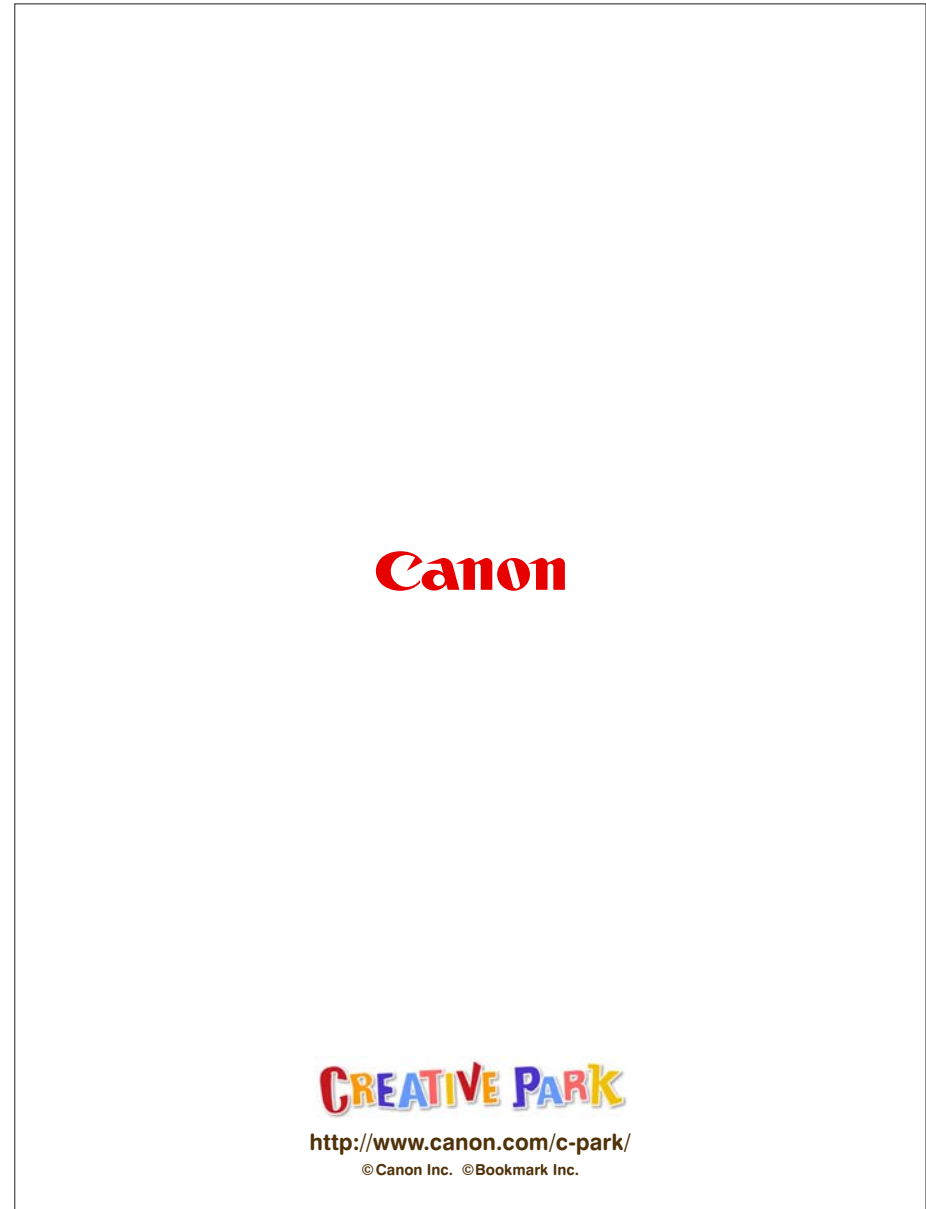

Materials

Prepare the materials. Cut out the parts and give mountain and valley folding in advance.

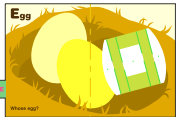
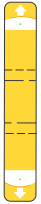

How to build the book

Glue in the order of the numbers.

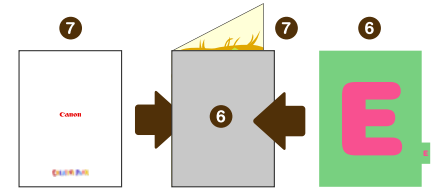
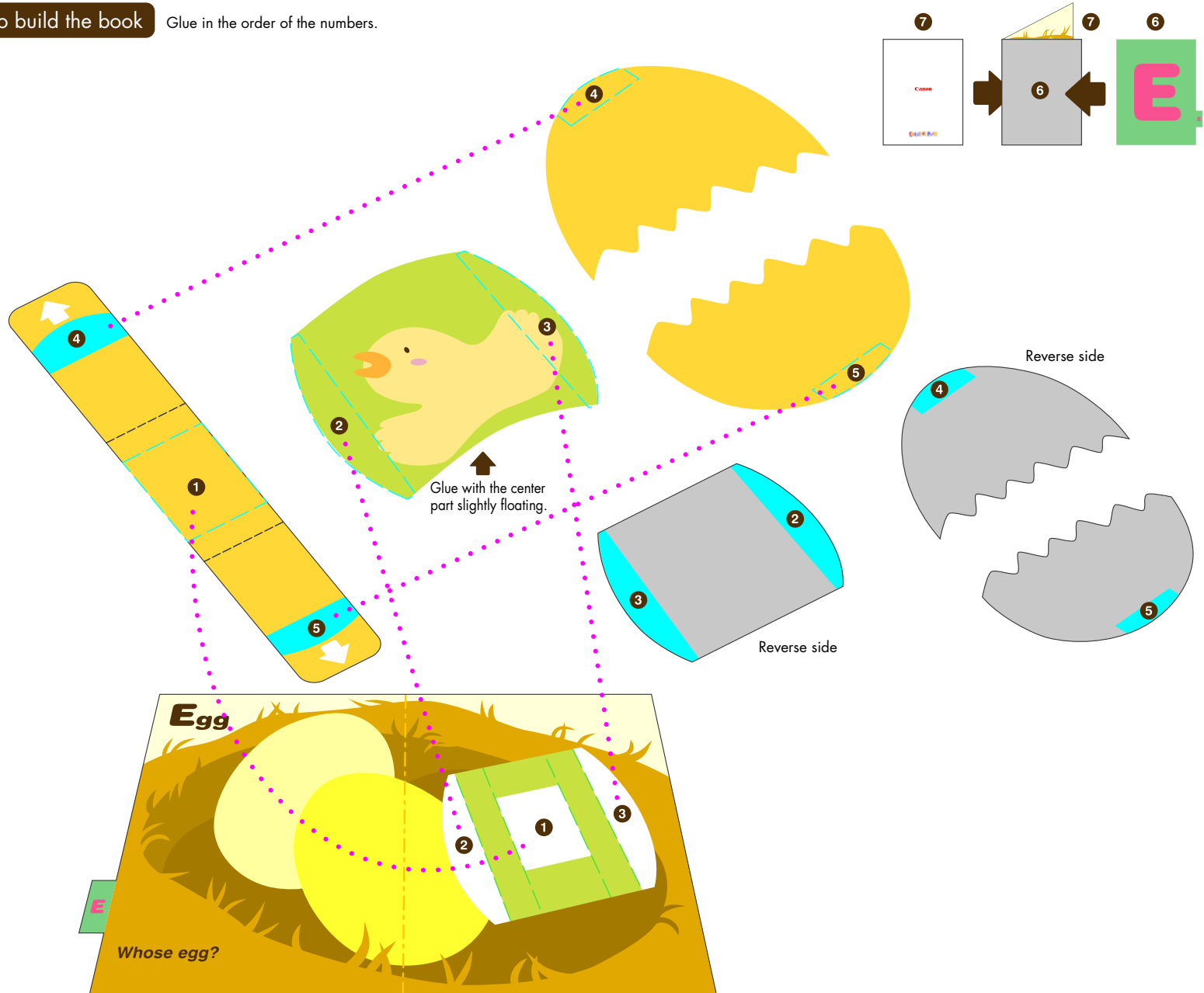

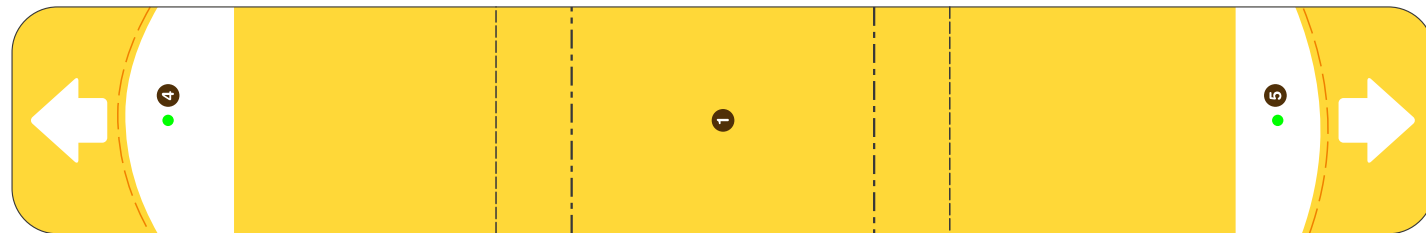
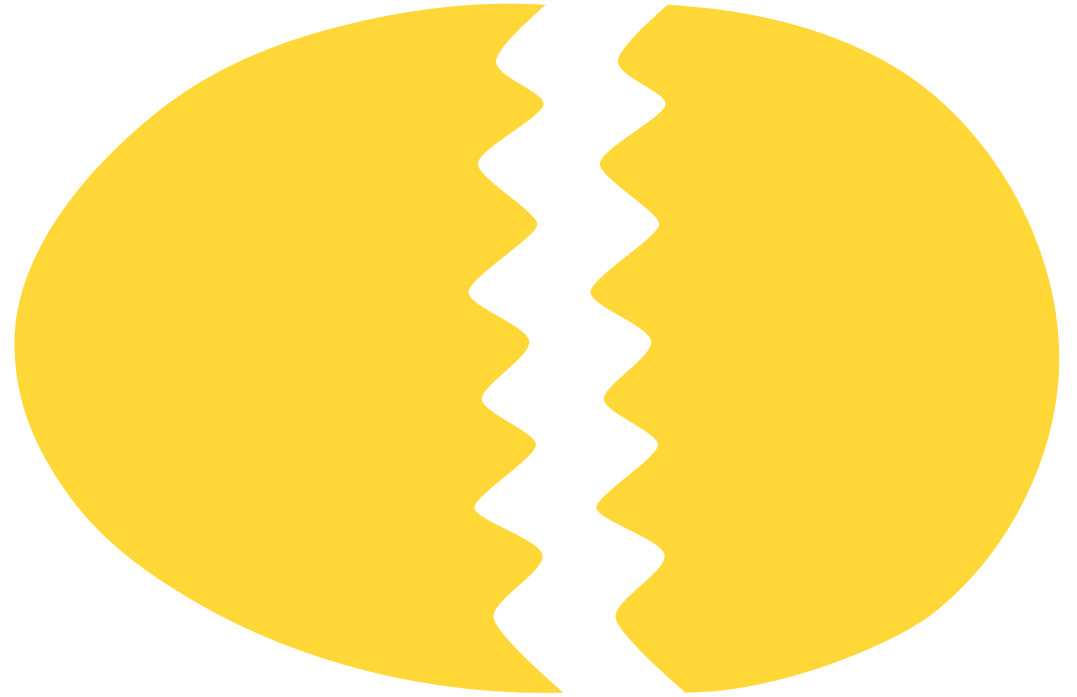

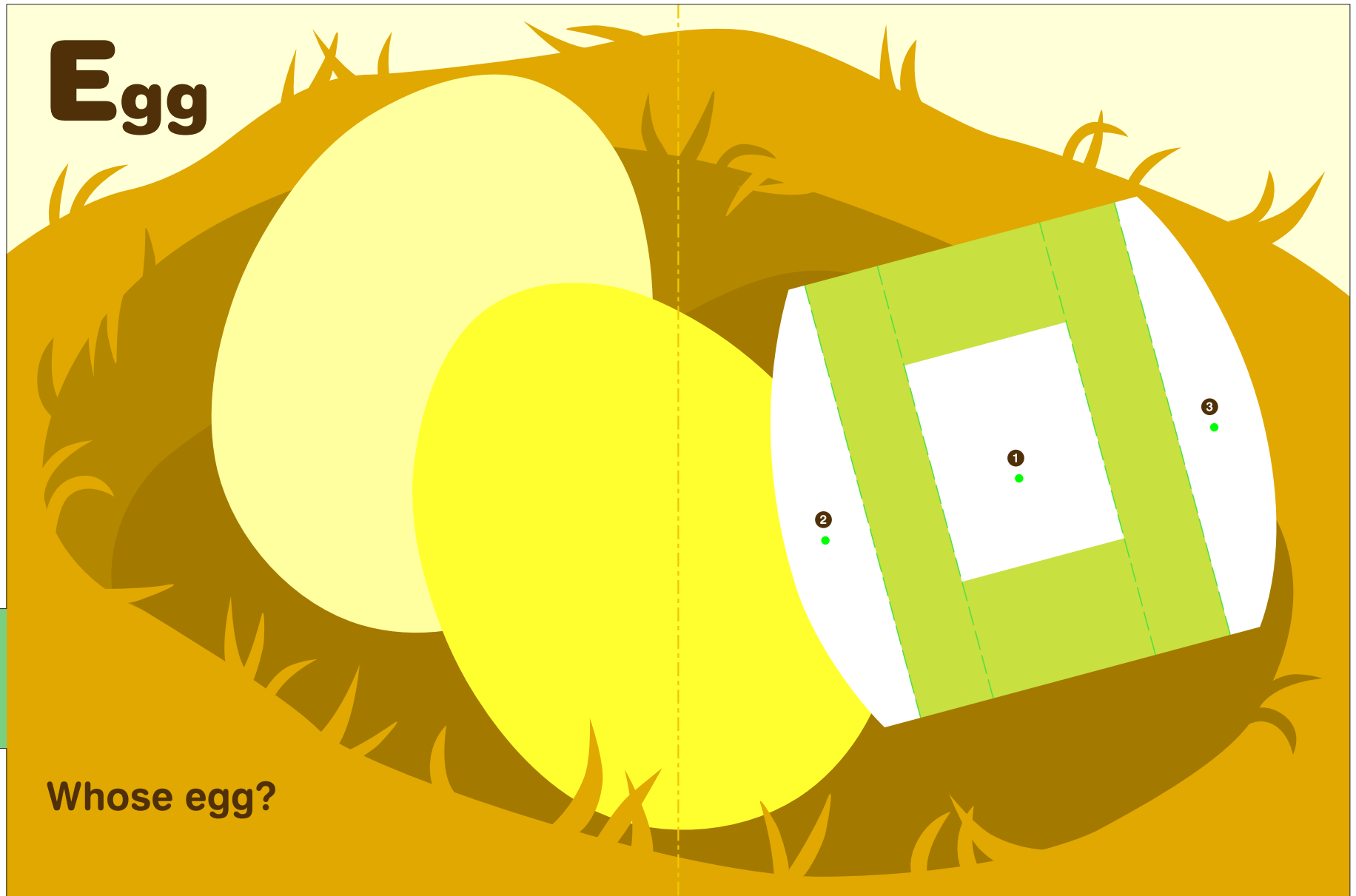

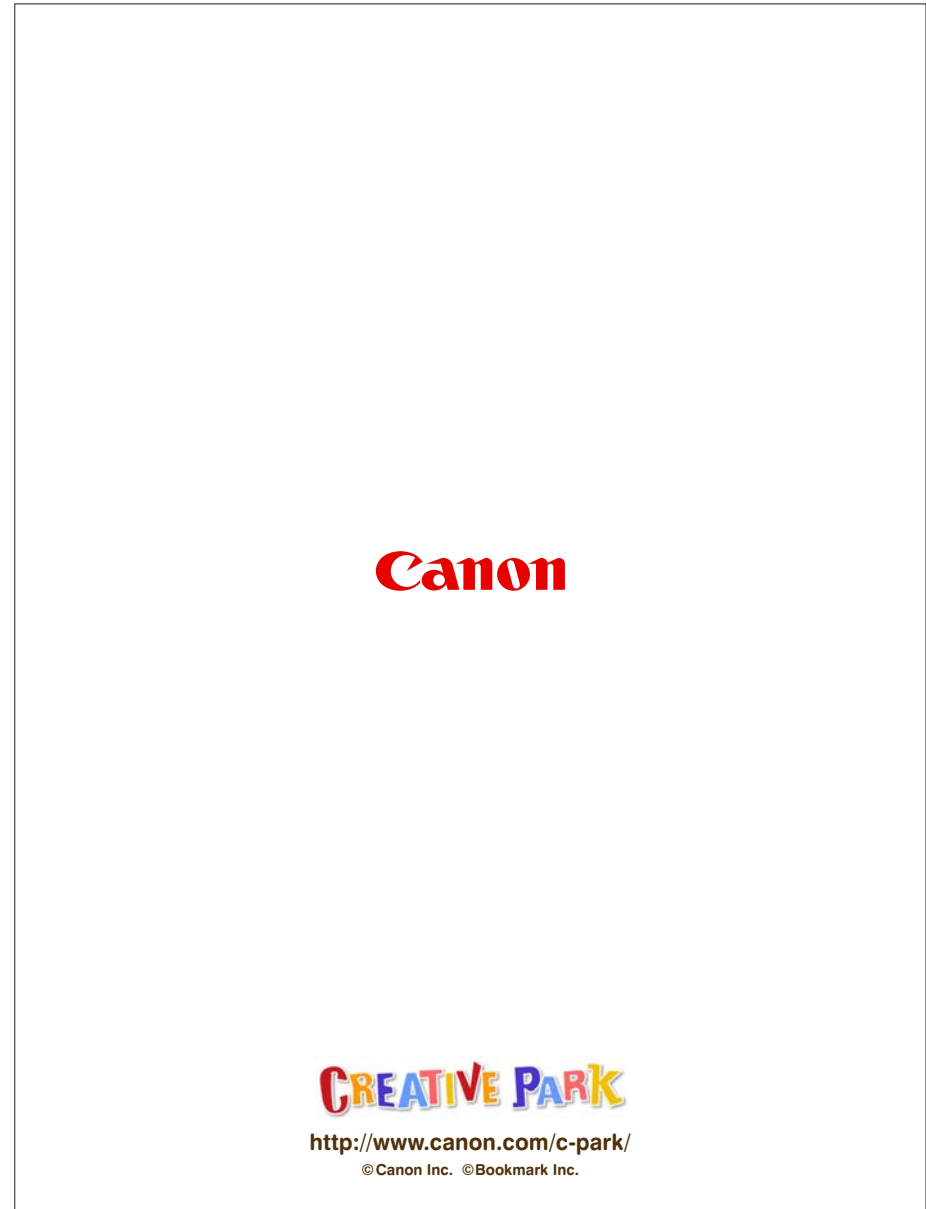

Canon

CREATIVE PARK

<http://www.canon.com/c-park/>

© Canon Inc. © Bookmark Inc.

Materials

Prepare the materials. Cut out the parts and give mountain and valley folding in advance.



How to build the book Glue in the order of the numbers.

Reverse side

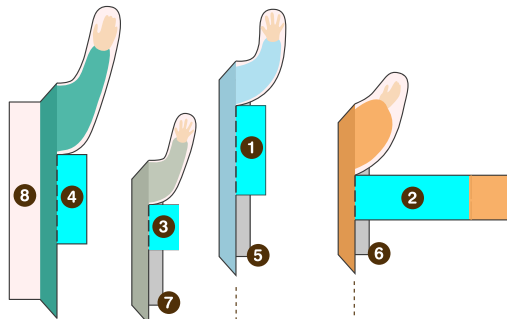
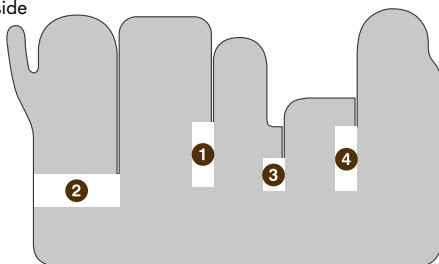

Front side

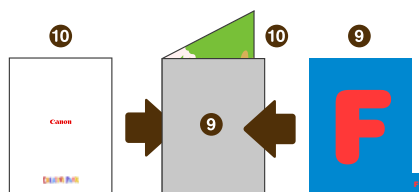
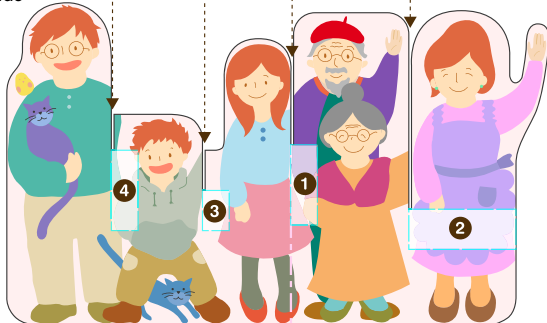

Reverse side

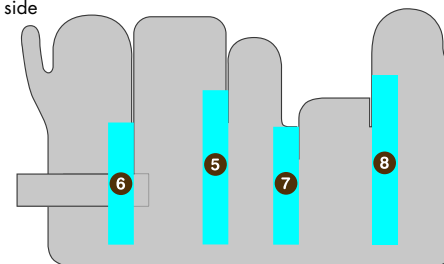

Front side

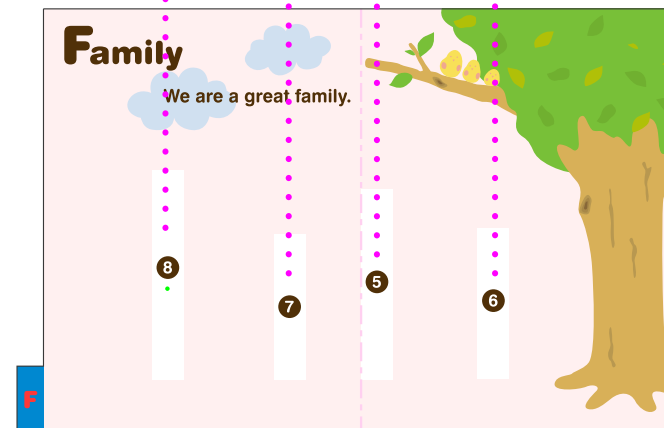
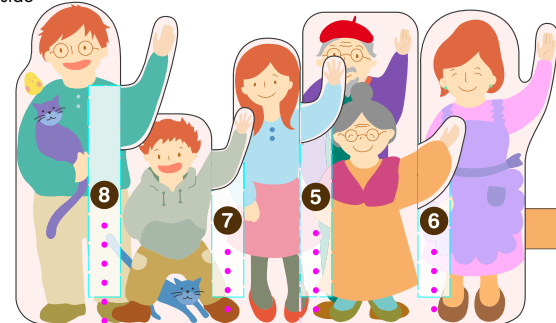



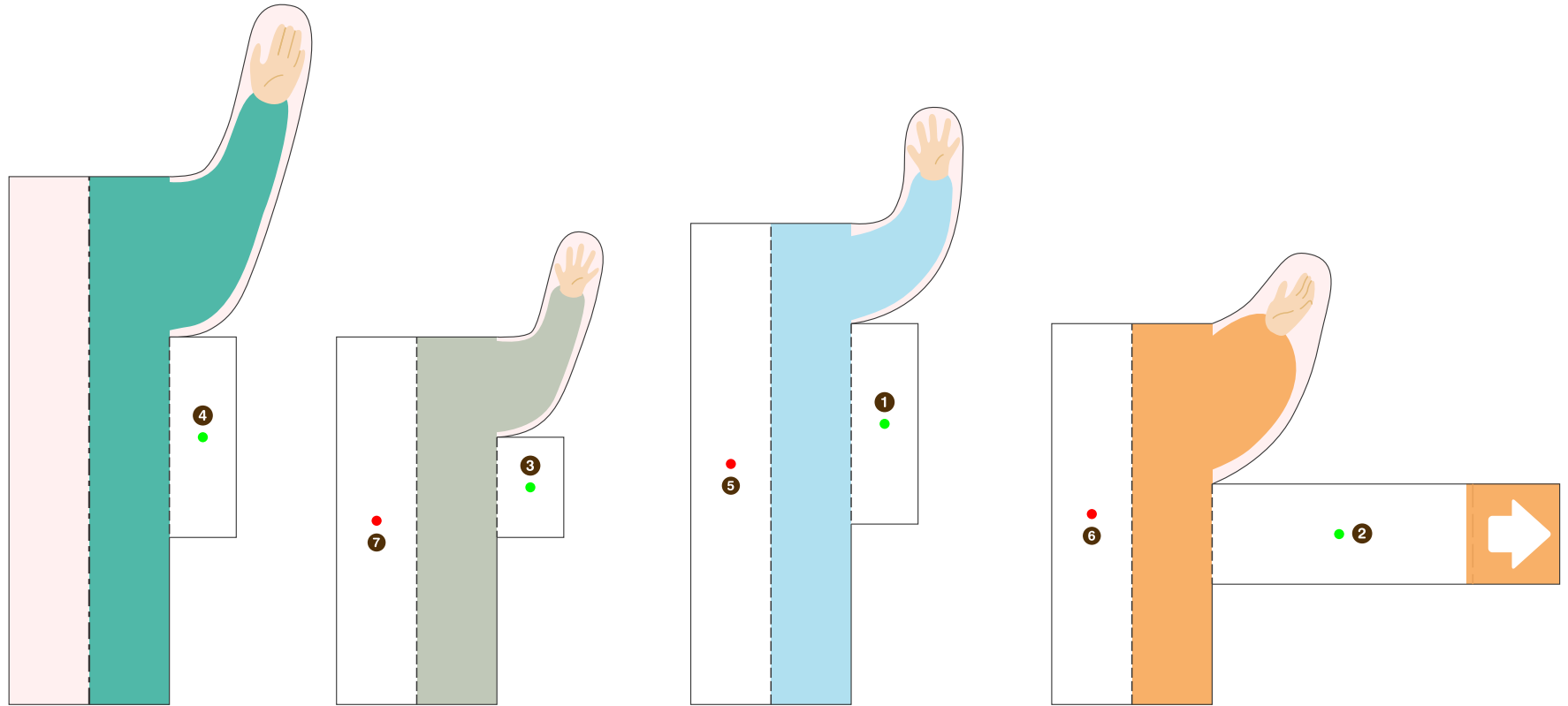

Family

We are a great family.

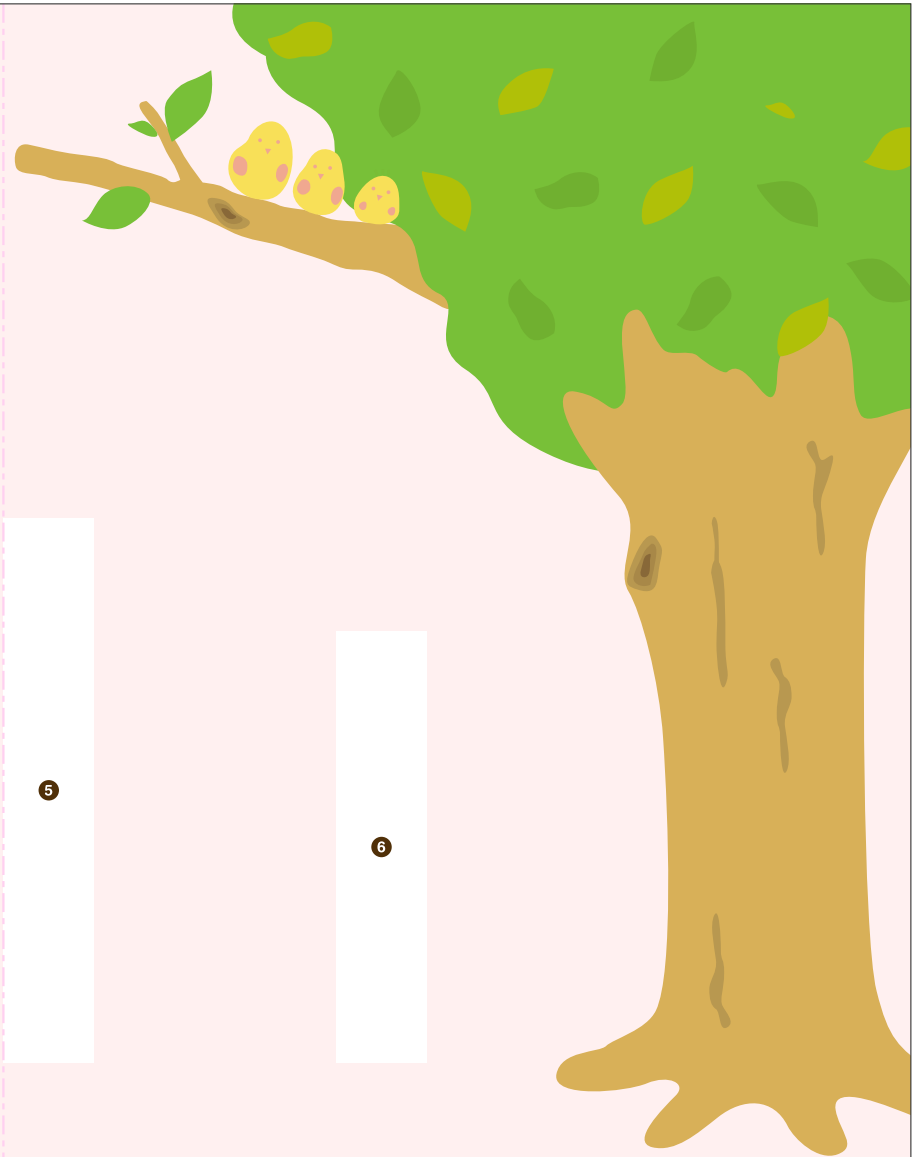
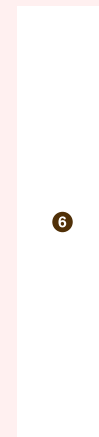

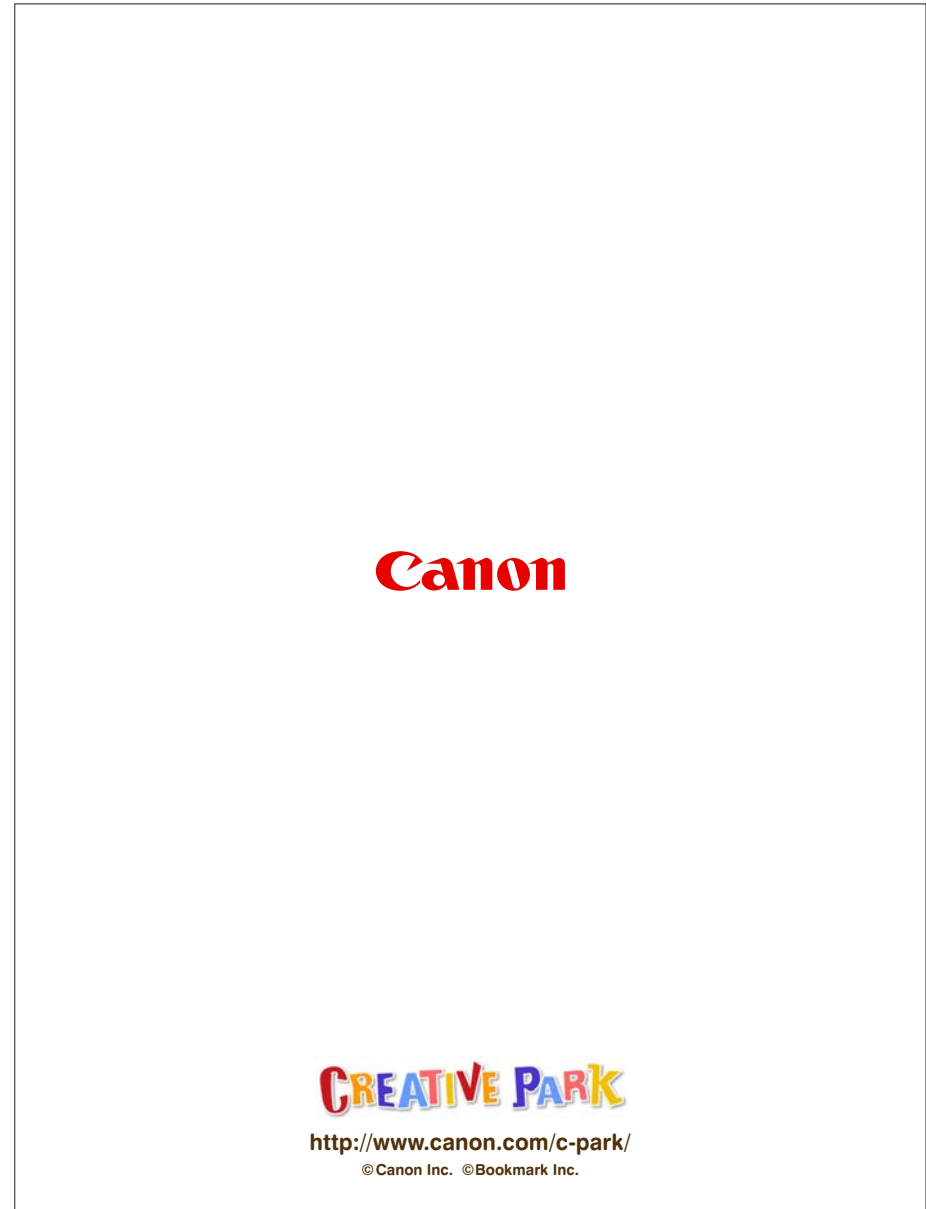

Materials

Prepare the materials. Cut the parts and give mountain and valley folding in advance.

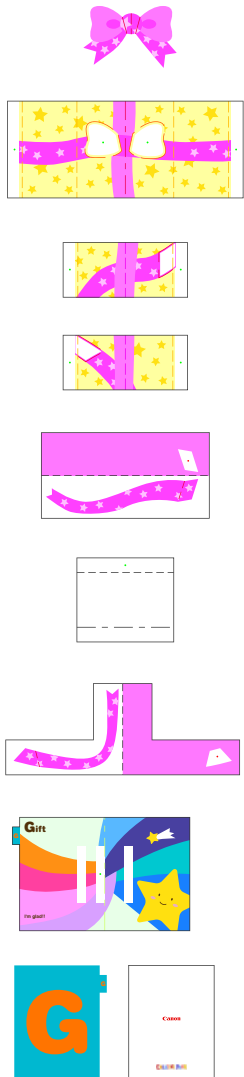

How to build the book

Glue in the order of the numbers.

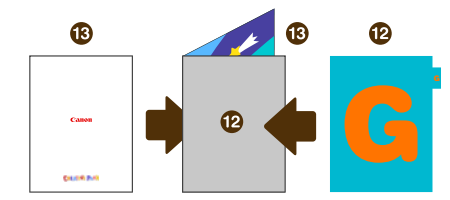
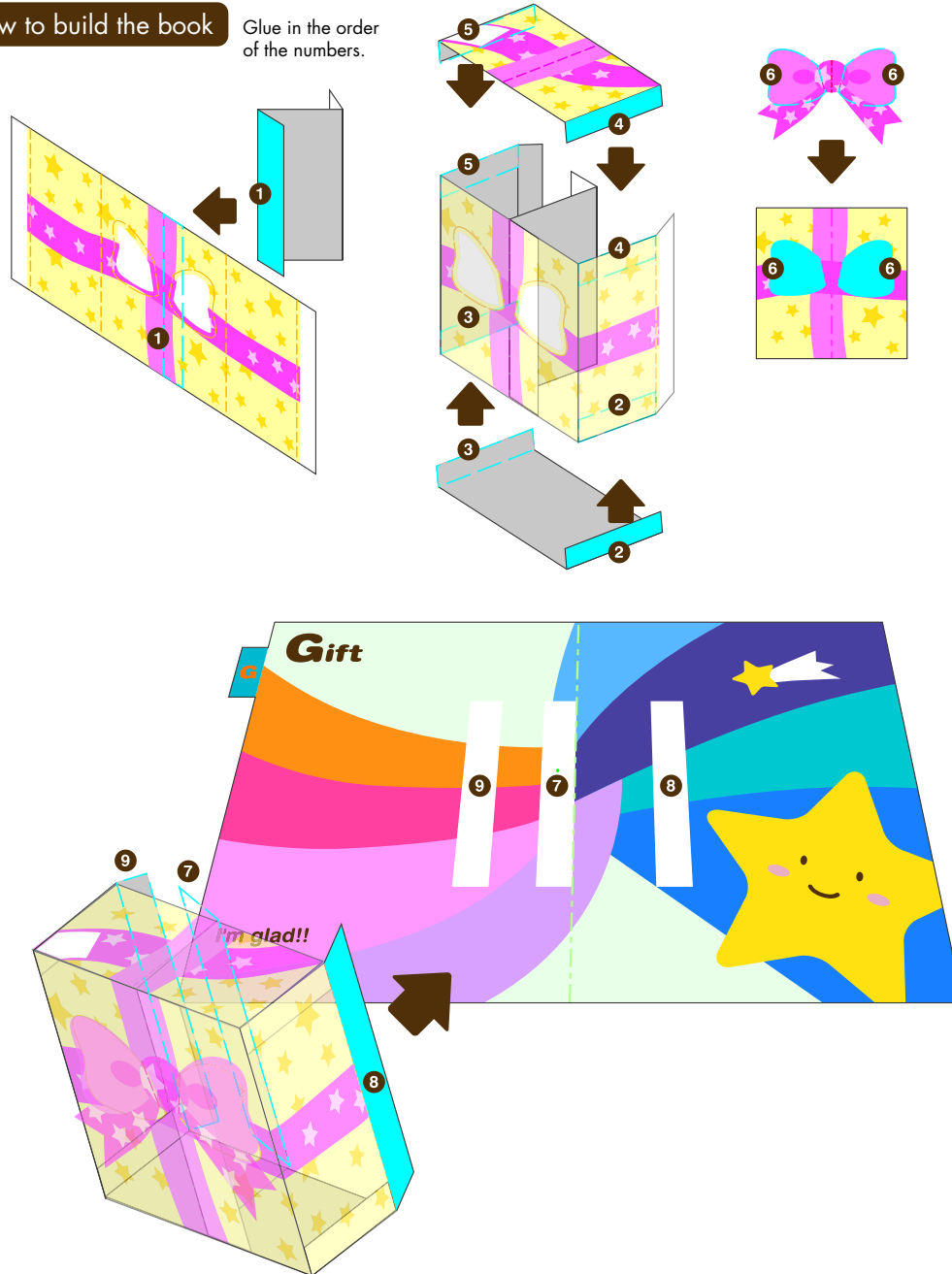

Give mountain folds, glue each of them and cut off the ribbon inside.

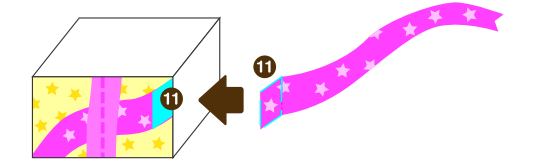
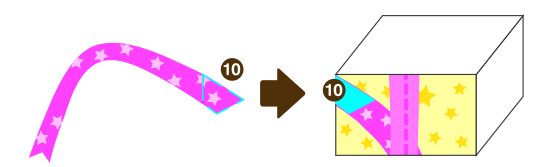
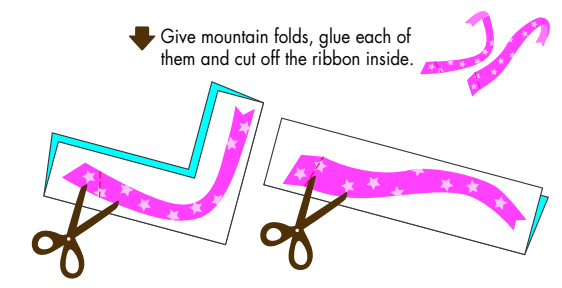

Cross the parts with numbers 10 and 11.

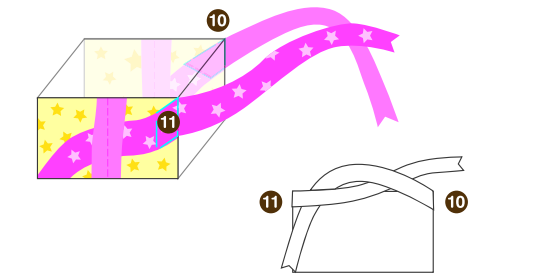

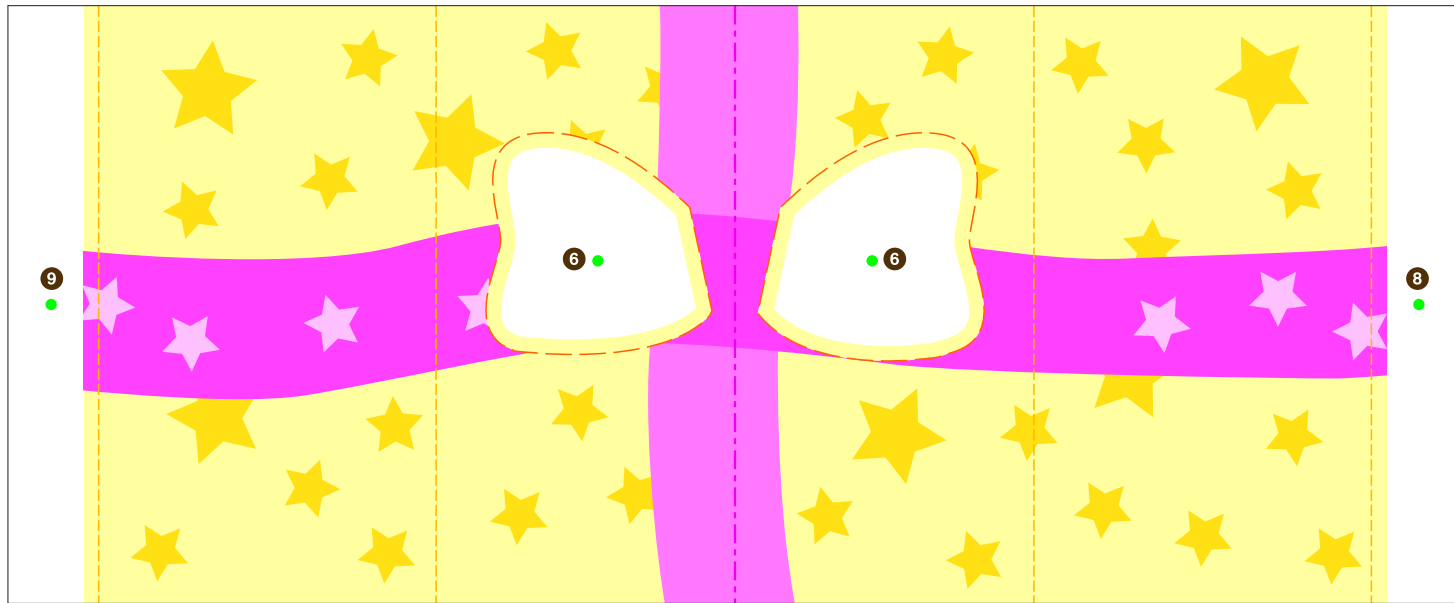
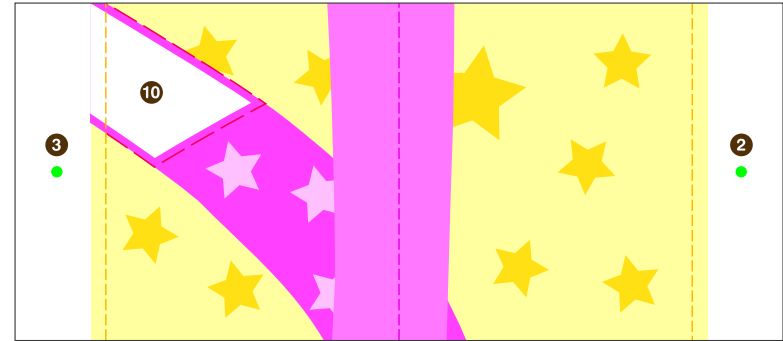
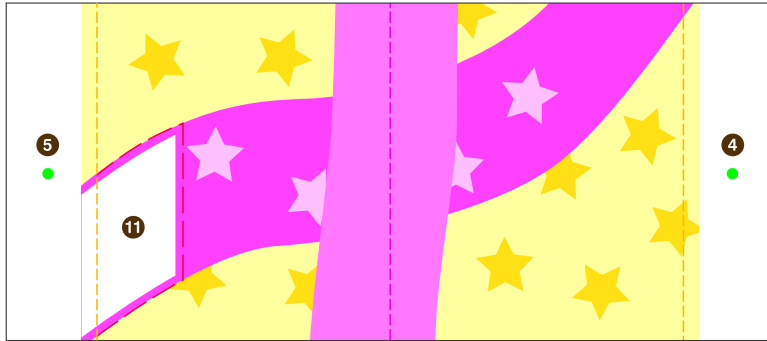

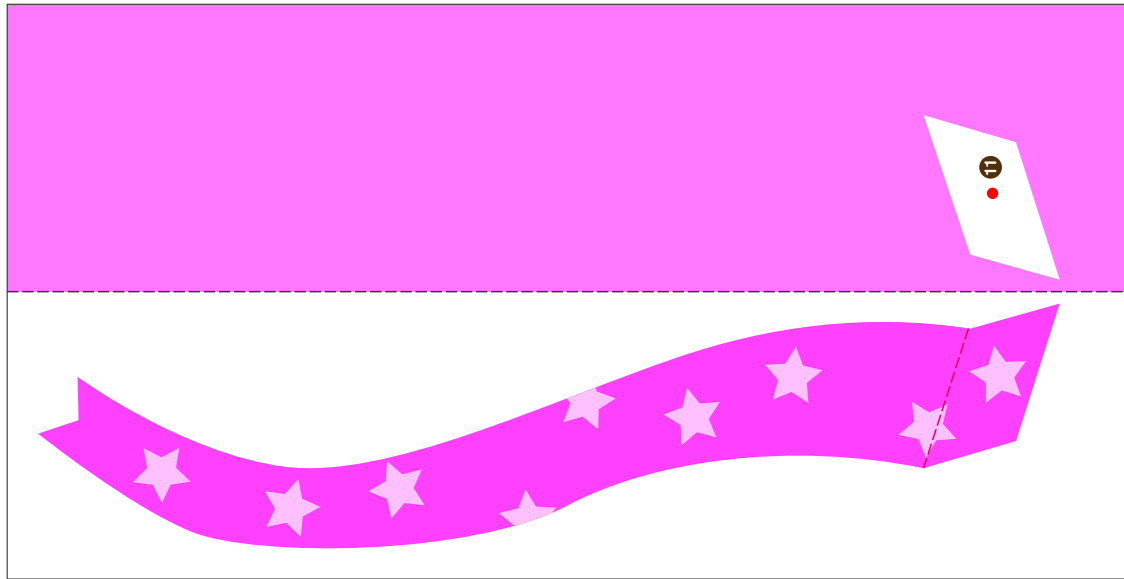

Give a mountain fold, glue it and cut off the ribbon inside.

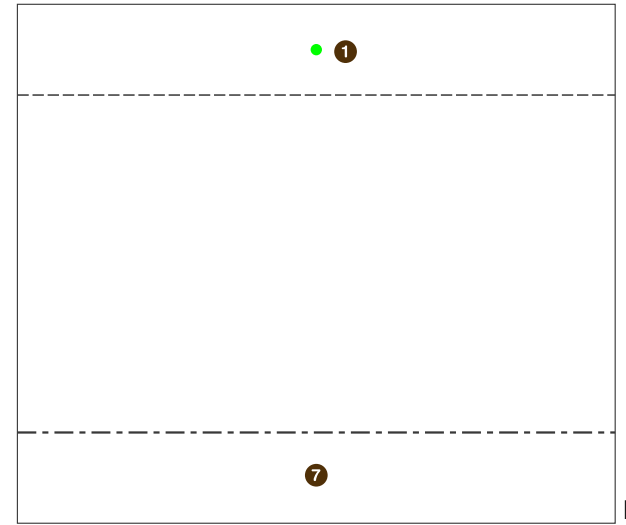

top

bottom

Give a mountain fold, glue it and cut off the ribbon inside.

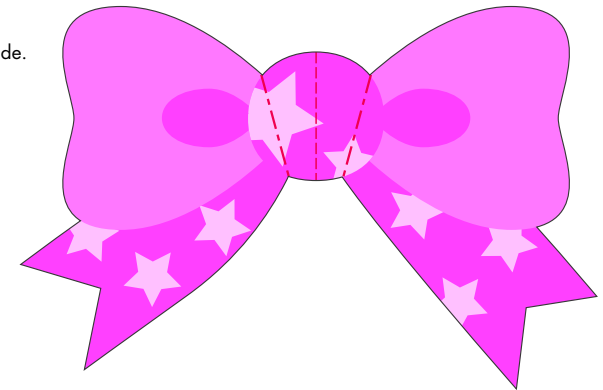
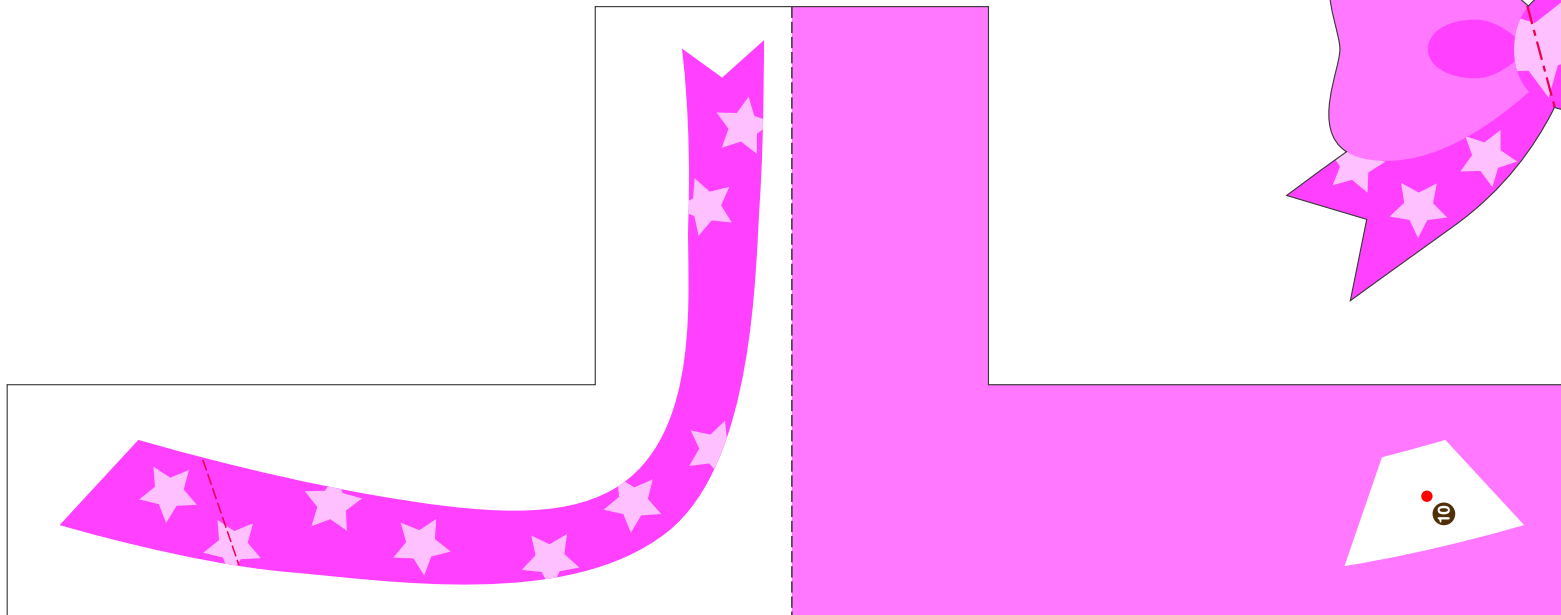

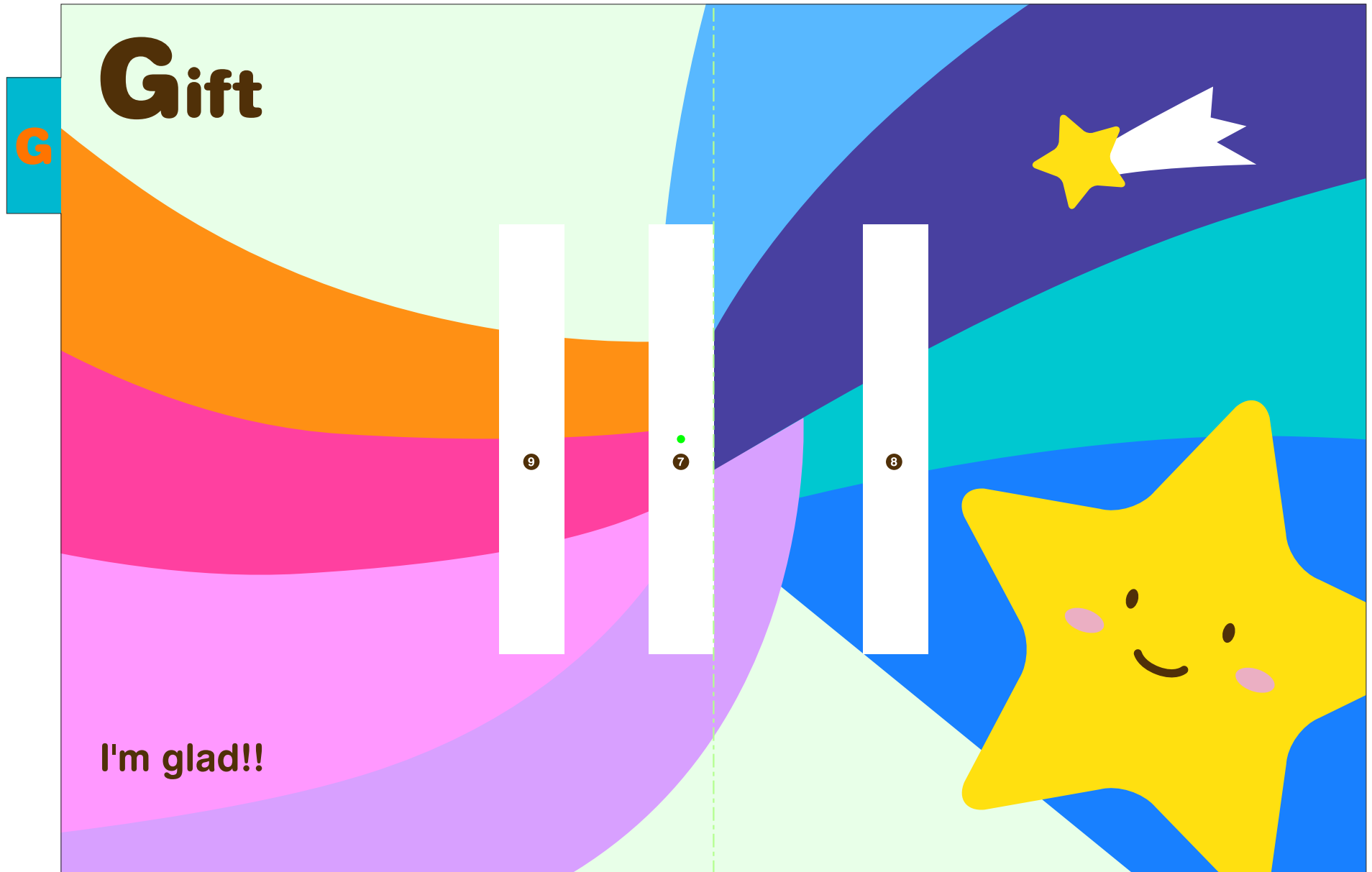

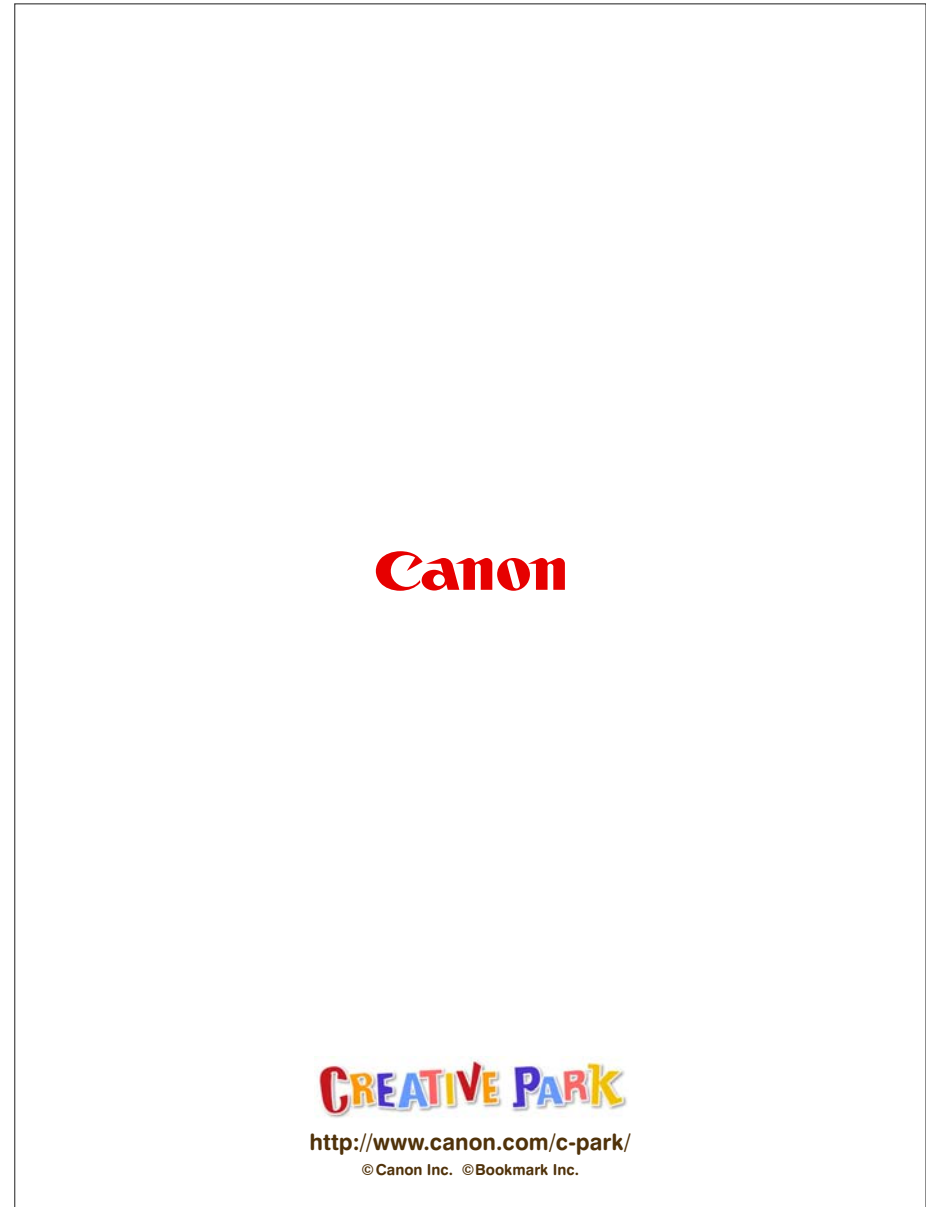

Materials

Prepare the materials. Cut out the parts and give mountain and valley folding in advance.

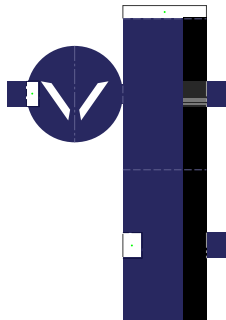
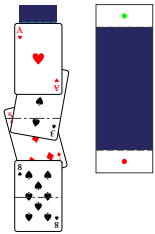
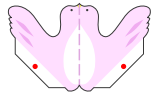

How to build the book Glue in the order of the numbers.

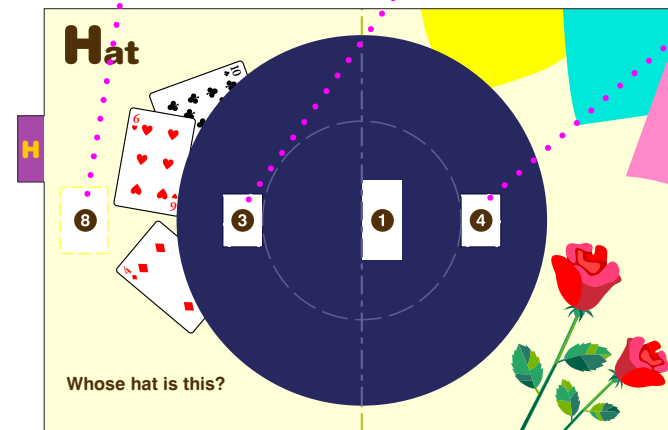
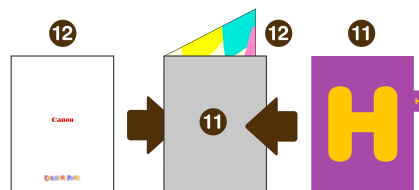
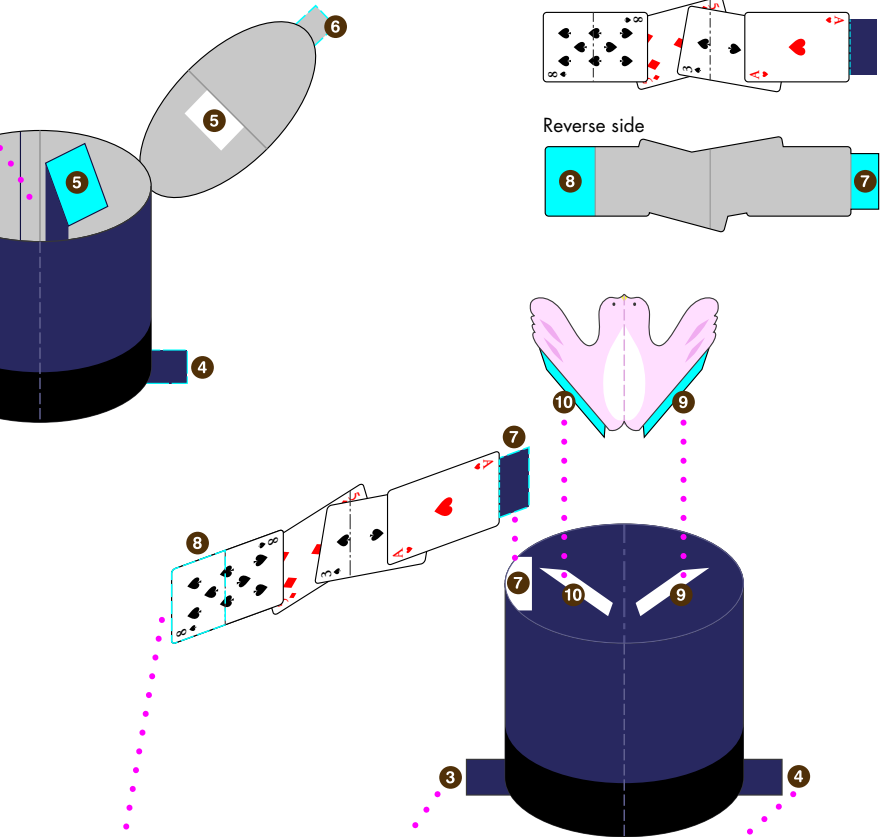
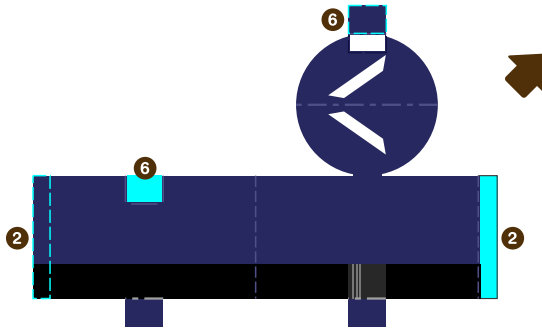
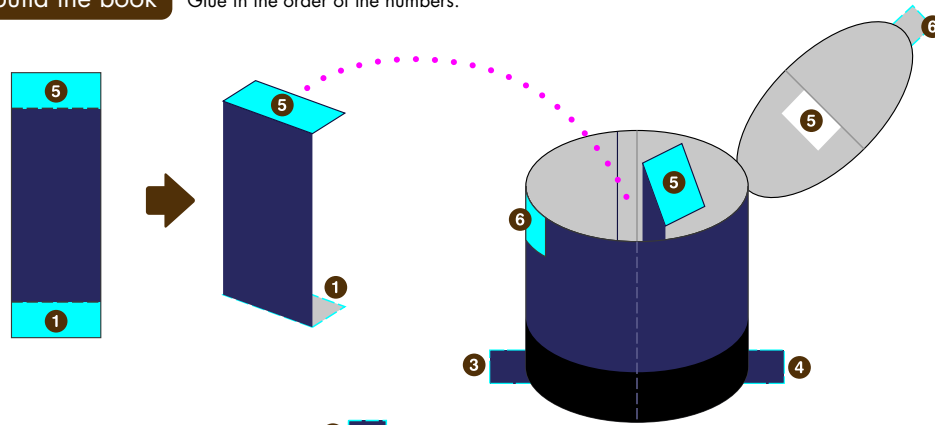

Front side

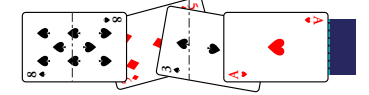

Reverse side

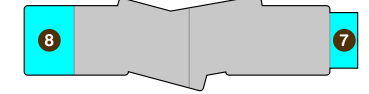

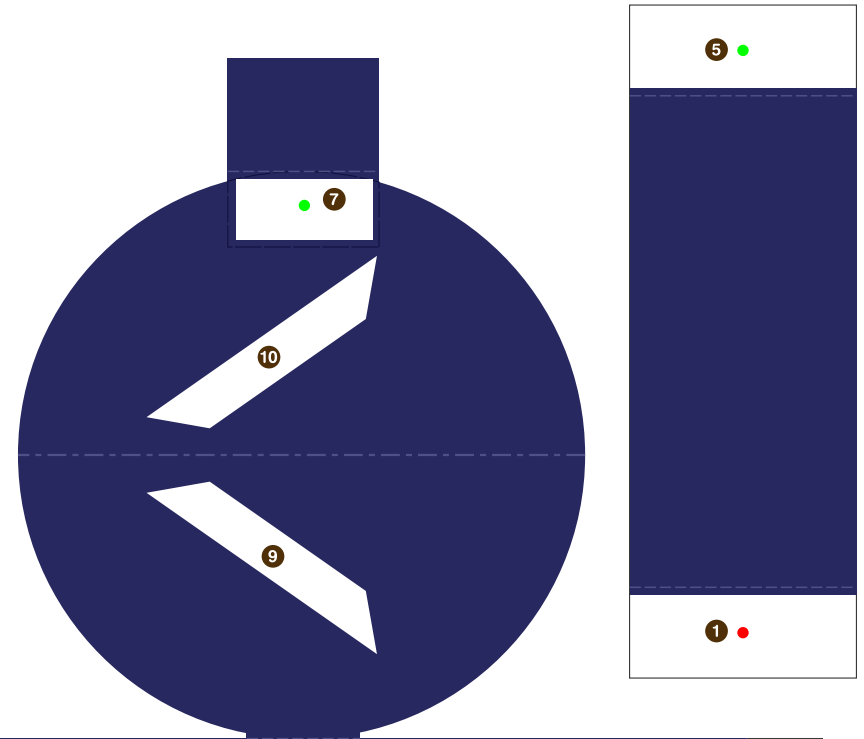
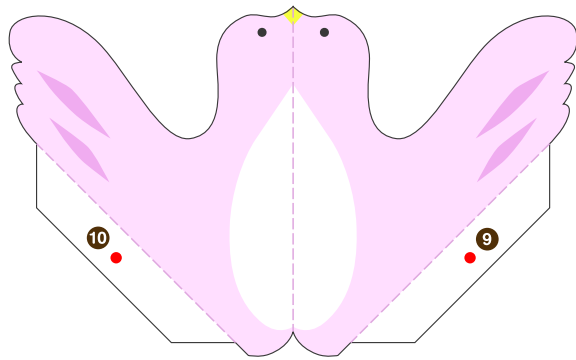
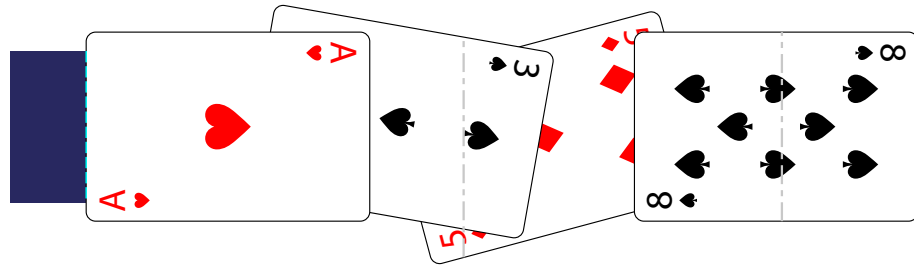

Hat

H

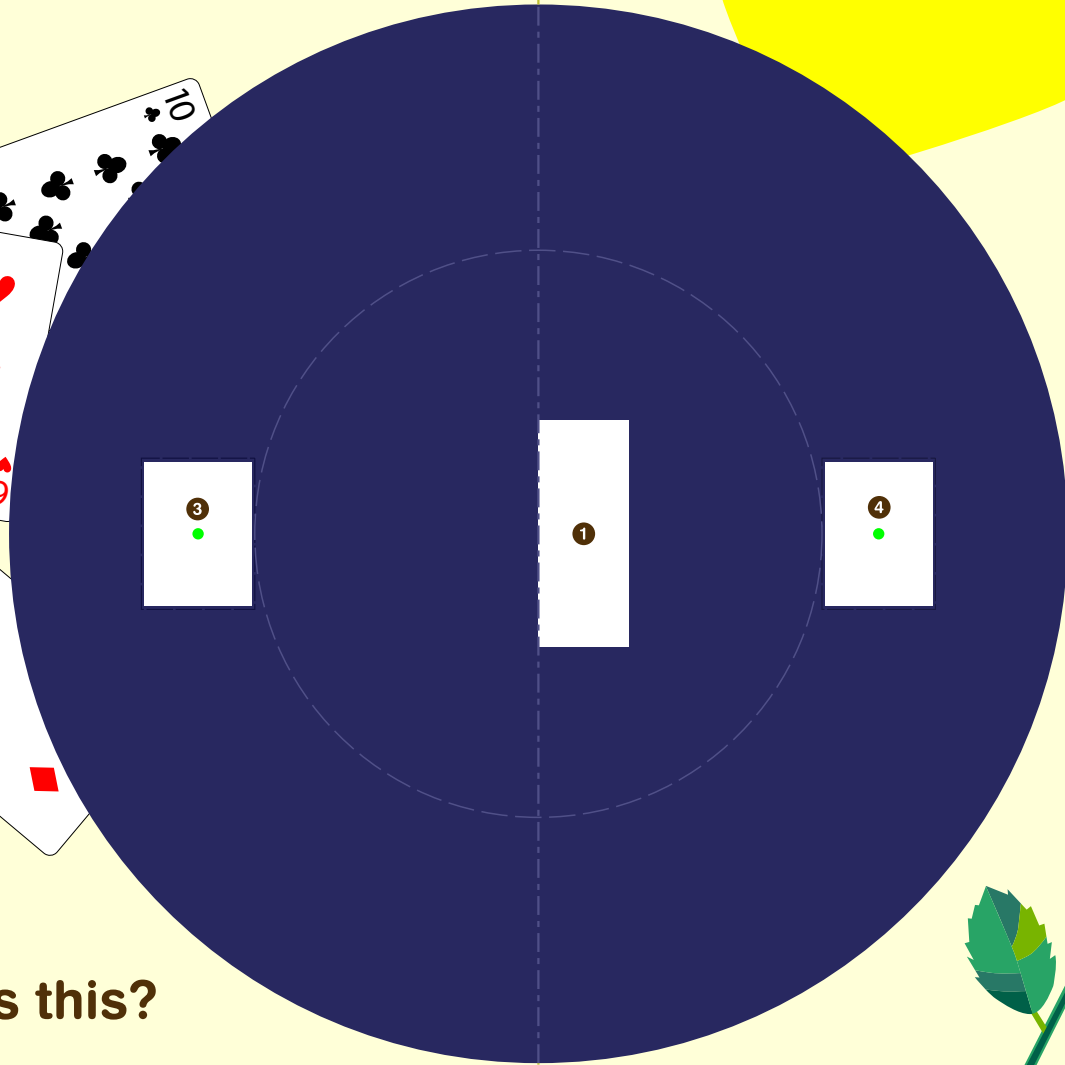
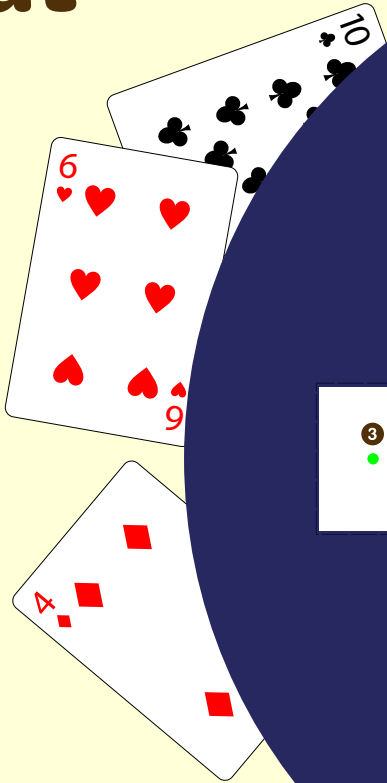
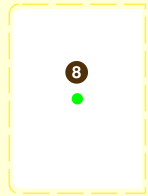

Whose hat is this?

